



CROMPTON INSTRUMENTS ANALOGUE METERS FOR MARINE APPLICATIONS

ANALOGUE INSTRUMENTS FOR MARINE APPLICATIONS

High quality analogue instruments designed to measure a wide range of electrical parameters. This comprehensive range offers quadratic instruments in different dimensions. Products are available as voltmeters, ammeters, voltmeters and ammeters incorporating a selector switch, power meters, energy meters incorporating a power indicator, process indicators and synchrosopes. To suit the needs of the shipbuilding and associated industries, manufacturing equipment for sea-going vessels, these instruments are CE marked and approved by Bureau Veritas (BV) under certification numbers 38933/A0 BV, 38940/A0 BV, 38941/A0 BV, 38942/A0 BV.



Features

- Extensive range
- Accurate measurement and display of electrical parameters
- Up to four different case sizes
- Wide range of specifications
- Designed for reliable operation in marine and offshore environments

Benefits

- Cost effective
- Local indication
- Easy installation
- Minimal operator training
- Low maintenance level

Applications

- Switchgear
- Distribution systems
- Control panels
- Process control
- Motor control

Approval

- Bureau Veritas

Standards

- CE marked
- BV approved

CONTENTS

Moving Iron Ammeters and Voltmeters	2
Moving iron AC voltmeters - available in four case sizes. Versions to reflect typical voltage transducer ratios in marine applications complete the range. Moving iron AC ammeters for direct AC currents or CT connections. Available in four case sizes with different inputs and scalings for no overload and 2 x or 6 x overload.	
AC Ammeters and Voltmeters Rectified	3
Rectified moving coil meters with shielded movement for linear AC measurement. Available in three case sizes for a wide range of inputs.	
DC Ammeters and Voltmeters	4-5
Used for direct measurement of DC signals. Available in four case sizes. Variations allow transducer and shunt indicators. Live zero, offset zero and centre zero measurement.	
AC Ammeters and Voltmeter with Selector Switch	6
Integrated selector switch reduces installation time and links the meter clearly to the switch. Ammeter is CT connected. Voltmeters are either direct or VT connected.	
Frequency Meters with Pointer or Reeds	7
Pointer indicator and reed indicator versions available for a variation of frequency ranges and different voltage levels.	
Phase Sequence Indicator	8
Phase sequence indicators are used to determine the correct phase sequence in three phase networks. Supplied with two built in glow bulbs indicating correct / incorrect sequence.	
Dual Voltmeter and Frequency Meter	9
Used for direct comparison of two electrical systems (bus and generator). Supports to determine the preconditions prior to parallel operation. Frequency meters available as pointer or reed versions.	
Power Factor Meters	10
Power factor meters determine if systems are running with inductive or capacitive load. Variation of system connections available. Including "through hole" CT connection.	
Wattmeters and Varmeters	11-13
Panel mounted energy meters combine a Watt or Varmeter with a counter for Watthours of Varhours. Available for different electrical systems and voltage levels. Relay output built in as standard	
Energy Meter with Power Indicator	14-16
Panel mounted energy meters combine a Watt or Varmeter with a counter for Watthours of Varhours. Available for different electrical systems and voltage levels. Relay output built in as standard.	
Synchroscope	17-18
Synchrosopes are used to prevent an asynchronous connection of bus and generator. Available as 360° LED indicators with different functionality. Version with additional LCD display available to show electrical values.	
Technical Details	19
Standards and Approvals	19

MOVING IRON AMMETERS AND VOLTMETERS

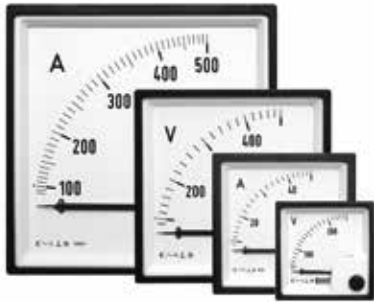

Features

- Measures AC current or voltage
- Direct or CT connected ammeters
- Direct or VT connected voltmeters
- Moving iron movement
- RMS measurement
- Scaled down to 15%
- Ammeters available with x2 or x6 overload scale

Benefits

- Easy to operate
- Exchangeable dial
- Terminal cover included

Applications

- AC switchgears, panels and distribution boards
- Motor current supervision

Construction

- Sprung pivot bearing type with silicon oil damping
- Slot in screw fixing

Standards

- CE marked
- BV approved

Order data/examples

Ammeter

- 1) Select type: M243-02A-S,
- 2) Specify input: 0-5A,
- 3) Specify scaling: 0-100A,
- 4) Specify frequency: 50/60Hz

General Specification

- Accuracy class - 1.5
- Maximum continuous overload - $1.2 \times I_n$, $1.2 \times U_n$
- Maximum short duration overload - $10 \times I_n - 9 \times 0.5s + 1 \times 5s/60s - 2 \times U_n - 9 \times 0.5s + 1 \times 5s/60s$
- Ammeter burden - 0.3 ... 1.2 VA
- Voltmeter burden - 1.5 ... 4 VA
- Frequency - 50/60 Hz

Product Codes

Bezel size (mm)	48	72	96	144
Scale length (mm)	41	62	92	135
AC ammeter	M242-02A-S	M243-02A-S	M244-02A-S	M246-02A-S
X2 AC ammeter	M242-022A-S	M243-022A-S	M244-022A-S	M246-022A-S
X6 AC ammeter	M242-026A-S	M243-026A-S	M244-026A-S	M246-026A-S
AC voltmeter	M242-02V-S	M243-02V-S	M244-02V-S	M246-02V-S
Standard input ranges				
AC ammeter (0/x A)	1, 2, 2.5, 4, 5, 6, 10, 15, 20, 25, 30, 40, 60 A (M242 limited to 25A)			
X2 AC ammeter (0/x A)	1/2, 2/4, 2.5/5, 4/8, 5/10, 60/12, 10/20, 15/30, 20/40, 30/60, 40/80, 60/120 A (M242 limited to 25/50A)			
X6 AC ammeter (0/x A)	1/6, 2/12, 2.5/15, 4/24, 5/30, 6/36, 10/60, 15/90, 20/120, 25/150, 30/180, 40/240, 50/300, 60/360 A (M242 limited to 25/150 A)			
AC voltmeter (0/x V)	250V, 300V, 500V, 600V			
AC voltmeter for VT connection (0/x V)	120V (for use with VT's x/100V), 132V (for use with VT's x/110V), 144V (for use with VT's 120V), 125V, 137.5V, 150V (for use with some VT's having primary voltage less than 1kV)			

Connection Diagrams

AC Ammeter

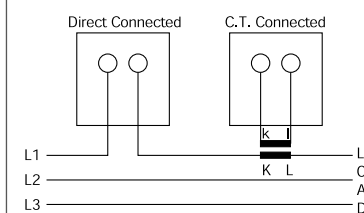

AC Voltmeter

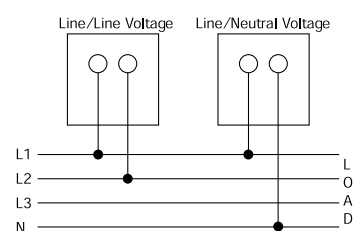

Voltmeter

- 1) Select type: M244-02V-S,
- 2) Specify input: 0-500V,
- 3) Specify scaling: 0-500V,
- 4) Specify frequency: 50/60Hz

Voltmeter, VT connected

- 1) Select type: M244-02V-S,
- 2) Specify input: 0-120V,
- 3) Specify scaling: 0-12kV,
- 4) Specify frequency: 50/60Hz,
- 5) Specify VT ratio: 10/0.1 kV

AC AMMETERS AND VOLTMETERS RECTIFIED



Features

- Measures AC current or voltage
- CT connected ammeters
- Direct and VT connected voltmeters
- Moving iron movement
- Linear scaling
- 90° short scale and 240° long scale version

Benefits

- Easy to operate
- Exchangeable dial
- Low consumption
- Terminal cover included

Applications

- AC switchgears, panels and distribution boards

Construction

- Mean value measurement of current or voltage
- Containing germanium diodes of low reverse current
- Slot in screw fixing

Standards

- CE marked
- BV approved

General Specification

- Accuracy class - 1.5
- Maximum continuous overload - $1.2 \times I_n$, $1.2 \times U_n$
- Maximum short duration overload - $10 \times I_n - 9 \times 0.5s + 1 \times 5s/60s$
 $2 \times U_n - 9 \times 0.5s + 1 \times 5s/60s$
- Frequency - 50/60 Hz

Product Codes

Bezel size (mm)	48	72	96	144
Scale length (mm)	41	62	92	135
AC ammeter rectified 90°	M242-01B-S	M243-01B-S	M244-01B-S	M246-01B-S
AC voltmeter rectified 90°	M242-01W-S	M243-01W-S	M244-01W-S	M246-01W-S
Bezel size (mm)	48	72	96	144
Scale length (mm)	71	113	155	235
AC ammeter rectified 240°	M242-05B-S	M243-05B-S	M244-05B-S	M246-05B-S
AC voltmeter rectified 240°	M242-05W-S	M243-05W-S	M244-05W-S	M246-05W-S
Standard input ranges				
AC ammeter rectified 90° and 240° scaling (0/x A) meter (0/x A)	1, 5 A (M242-05B-S delivered with separated current transformer)			
AC voltmeter rectified 90° and 240° scaling (0/x V)	20, 15, 20, 30, 60, 100, 150, 250, 300 (limit at M242). 400, 500, 600 V			
AC voltmeter for VT connection (0/x V)	120V (for use with VT's x/100V), 132V (for use with VT's x/110V), 144V (for use with VT's 120V), 125V, 137.5V, 150V (for use with some VT's having primary voltage less than 1kV)			

Connection Diagrams

AC Ammeter

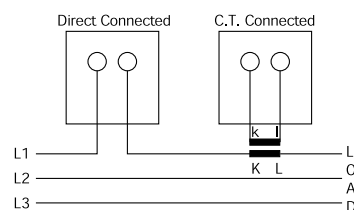

AC Voltmeter

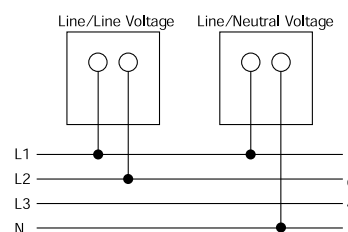

Order data/examples

Ammeter

- 1) Select type: M243-01B-S,
- 2) Specify input: 0-1A,
- 3) Specify scaling: 0-1kA,
- 4) Specify frequency: 50/60Hz

Voltmeter

- 1) Select type: M244-05W-S,
- 2) Specify input: 0-500V,
- 3) Specify scaling: 0-500V,
- 4) Specify frequency: 50/60Hz

Voltmeter, VT connected

- 1) Select type: M244-05W-S,
- 2) Specify input: 0-120V,
- 3) Specify scaling: 0-12kV,
- 4) Specify frequency: 50/60Hz,
- 5) Specify VT ratio: 10/0.1 kV

DC AMMETERS AND VOLTMETERS



General Specification

- Accuracy class - 1.5
- Maximum continuous overload - $1.2 \times I_n$, $1.2 \times U_n$
- Maximum short duration overload -
 $10 \times I_n - 9 \times 0.5s + 1 \times 5s / 60s$
 $2 \times U_n - 9 \times 0.5s + 1 \times 5s / 60s$

Features

- Measures DC current or voltage
- Direct and shunt connected ammeters
- Direct connected voltmeters
- Live zero ammeters and voltmeters
- Centre zero ammeters and voltmeters
- Moving coil movement
- Linear scaling
- 90° short scale and 240° long scale version

Benefits

- Easy to operate
- Exchangeable dial
- Terminal cover included

Applications

- DC switchgears, panels and distribution boards
- Control boards
- Process indication
- Battery supervision

Construction

- Magnet core none sensitive to external fields
- Slot in screw fixing

Standards

- CE marked
- BV approved

Product Codes

Bezel size (mm)	48	72	96	144
Scale length (mm)	41	62	92	135
DC ammeter 90°	M242-01A-S	M243-01A-S	M244-01A-S	M246-01A-S
DC voltmeter 90°	M242-01V-S	M243-01V-S	M244-01V-S	M246-01V-S
DC ammeter 90° live zero	M242-01R-S	M243-01R-S	M244-01R-S	M246-01R-S
DC voltmeter 90° live zero	M242-01S-S	M243-01S-S	M244-01S-S	M246-01S-S
DC ammeter 90° centre zero	M242-01C-S	M243-01C-S	M244-01C-S	M246-01C-S
DC voltmeter 90° centre zero	M242-01N-S	M243-01N-S	M244-01N-S	M246-01N-S
Bezel size (mm)	48	72	96	144
Scale length (mm)	71	113	155	235
DC ammeter 240°	M242-05A-S	M243-05A-S	M244-05A-S	M246-05A-S
DC voltmeter 240°	M242-05V-S	M243-05V-S	M244-05V-S	M246-05V-S
DC ammeter 240° live zero	M242-05R-S	M243-05R-S	M244-05R-S	M246-05R-S
DC voltmeter 240° live zero	M242-05S-S	M243-05S-S	M244-05S-S	M246-05S-S
DC ammeter 240° centre zero	M242-05C-S	M243-05C-S	M244-05C-S	M246-05C-S
DC voltmeter 240° centre zero	M242-05N-S	M243-05N-S	M244-05N-S	M246-05N-S
Standard input ranges				
DC ammeter 90° and 240° scaling (0/x A)	1, 1.5, 2.5, 4, 5, 6, 10, 15, 20, 25 (limit on M242), 30, 40, 50, 60 A			
DC ammeter 90° and 240° scaling, process and shunt indicators	0-1, 0-5, 0-10, 0-20, 4-20 mA, 0-50, 0-60, 0-75 mV			
DC ammeter 90° and 240° scaling, centre zero (x-0-x A)	1-0-1, 1.5-0-1.5, 2.5-0-2.5, 4-0-4, 5-0-5, 6-0-6, 10-0-10 (limit on M242), 15-0-15, 20-0-20, 25-0-25, 30-0-30 A			
DC ammeter 90° and 240° scaling, centre zero process and shunt indicators	1-0-1, 5-0-5, 10-0-10, 20-0-20 mA, 50-0-50, 60-0-60, 75-0-75 mV			
DC voltmeter 90° and 240° scaling (0/x V)	10, 15, 20, 30, 60, 100, 150, 250, 300 (limit on M242). 400, 500, 600 V			
DC voltmeter 90° and 240° scaling, process indicators	1-5, 2-10 V			
DC voltmeter 90° and 240° scaling, centre zero (x-0-x V)	10-0-10, 15-0-15, 20-0-20, 30-0-30, 60-0-60, 100-0-100, 150-0-150 (limit on M242) 250-0-250, 300-0-300 V			

Connection Diagrams

DC Voltmeter

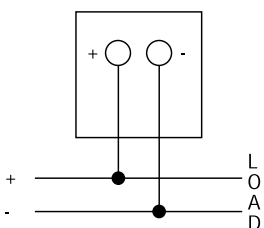

DC Ammeter

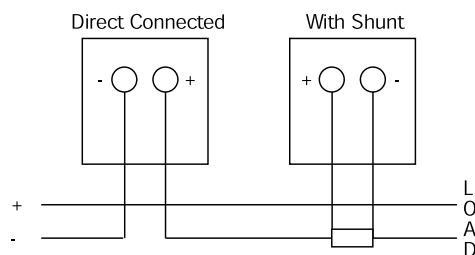

Transducer Indicator

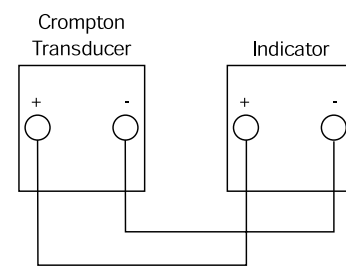

Order data/examples

Ammeter

Example A

- 1) Select type: M243-01A-S,
- 2) Specify input: 0-10 A,
- 3) Specify scaling: 0-10 A

Example B

- 1) Select type: M244-05R-S,
- 2) Specify input: 4-20 mA,
- 3) Specify scaling: 0-100 MVA

Example C

- 1) Select type: M244-01C-S,
- 2) Specify input: 60-0-60 mV,
- 3) Specify scaling: 150-0-150 A

Voltmeter

Example A

- 1) Select type: M244-01V-S,
- 2) Specify input: 0-15 V,
- 3) Specify scaling: 0-15 V

Example B

- 1) Select type: M244-05S-S,
- 2) Specify input: 2-10 V,
- 3) Specify scaling: 0-100 %

Example C

- 1) Select type: M242-01N-S,
- 2) Specify input: 10-0-10 V,
- 3) Specify scaling: 20-0-20 A

AC AMMETERS AND VOLTMETER WITH SELECTOR SWITCH



Features

- Measures AC current or voltage
- CT connected ammeters
- Direct and VT connected voltmeters
- Voltmeter available in 72mm x 72mm and 96mm x 96 mm
- Ammeter with moving coil rectified movement
- Voltmeter with moving iron movement

Benefits

- Easy to operate
- Exchangeable dial
- Terminal cover included
- Space saving
- Clear link between switch and meter

Applications

- AC switchgears, panels and distribution boards
- Control boards

Construction

- Ammeter measures mean value of rectified current
- Voltmeter measures true RMS value independent from waveform
- Slot in screw fixing

Standards

- CE marked
- BV approved

General Specification

- Accuracy class - 1.5
- Maximum continuous overload - $1.2 \times I_n$, $1.2 \times U_n$
- Maximum short duration overload - $10 \times I_n$ - $9 \times 0.5s + 1 \times 5s/60s$ - $2 \times U_n$ - $9 \times 0.5s + 1 \times 5s/60s$
- Voltage drop ammeter - $x/5A$ approx. 0.03 V, $x/1A$ approx. 0.1 V
- Burden voltmeter - 1.5 ... 4 VA
- Voltmeter switch - L1-L2/L2-L3/L1-L3/L1-N/L2-N/L3-N
- Ammeter switch - L1/L2/L3/OFF

Product Codes

Bezel size (mm)	-	72	96	-
Scale length (mm)	-	63	92	-
AC ammeter with switch	-	-	M244-02E-S	-
AC voltmeter with switch	-	M243-02Q-S	M244-02Q-S	-

Standard input ranges

AC ammeter with switch (0/x A)	1, 5 A
AC voltmeter with switch (0/x V)	250V, 300V, 500V, 600V
AC voltmeter for VT connection (0/x V)	120V (for use with VT's $x/100V$), 132V (for use with VT's $x/110V$), 144V (for use with VT's 120V), 125V, 137.5V, 150V (for use with some VT's having primary voltage less than 1kV)
Frequency	50/60 Hz

Connection Diagrams

Voltmeter with switch

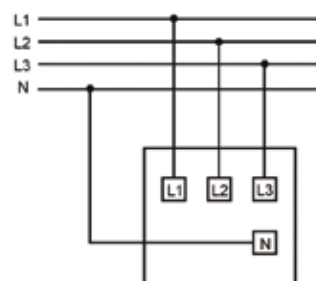

Ammeter with switch

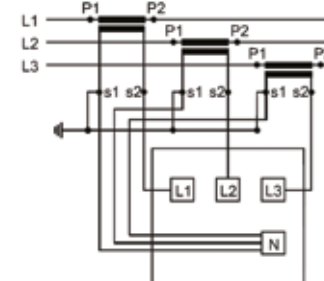

Order data/examples

Ammeter with switch

- 1) Select type: M244-02E-S,
- 2) Specify input: 0-5A,
- 3) Specify scaling: 0-100A,
- 4) Specify frequency: 50/60Hz

Voltmeter

- 1) Select type: M244-02Q-S,
- 2) Specify input: 0-500V,
- 3) Specify scaling: 0-500V,
- 4) Specify frequency: 50/60Hz

Voltmeter, VT connected

- 1) Select type: M244-02Q-S,
- 2) Specify input: 0-120V,
- 3) Specify scaling: 0-12kV,
- 4) Specify frequency: 50/60Hz,
- 5) Specify VT ratio: 10/0.1 kV

FREQUENCY METERS WITH POINTER OR REEDS



Features

- Measures AC frequencies
- Pointer type available as 90° short scale and 240° long scale version
- Reed type available with
 - 13 reeds (47-53 Hz, 57-63 Hz)
 - 21 reeds (45-55 Hz, 55-65 Hz)
- Direct or VT connected

Benefits

- Easy to operate
- High visibility
- Terminal cover included

Applications

- AC switchgears, panels and distribution boards
- Control board
- Generator sets

Construction

- Pointer type contains internal transducer, powered from input voltage and moving coil meter
- Reed type uses steel reeds in an electromagnetic field. Reeds are calibrated to its individual frequency to vibrate in resonance with the electromagnet and vibrates at full amplitude

Standards

- CE marked
- BV approved

General Specification

- Accuracy class - 0.5 - 1.2 x Un continuously
- Overload - 1.5 x Un for 2 hours (pointer type only) - 2 x Un for 5 seconds - 1 VA at nominal voltage 57-110 V and 230 V
- Burden pointer type - 1.7 VA at nominal voltage 400V - 2VA at nominal voltage 500V
- Burden reed type - 0.7 ... 1.2 VA at nominal voltage 110-230 V - 1.4 ... 2 VA at all other nominal voltages

Product Codes

Bezel size (mm)	96	96	96	96
Scale length (mm)	95	135	-	-
Frequency meter 90°	M244-41S-S	-	-	-
Frequency meter 240°	-	M244-41L-S	-	-
Frequency meter 13 reeds	-	-	M244-41R-S	-
Frequency meter 21 reeds	-	-	-	M244-41R-S
Standard input ranges				
Pointer type	57-110 V, 400V +/- 20%, 500V +/-20%			
Reed type	100V, 110V, 230V, 400V +/- 20%, 500V +/-20%			
Scaling				
13 reeds on reed type meters with scaling:	47-50-53 Hz, 57-60-63 Hz			
21 reeds on reed type meters with scaling:	45-50-55 Hz, 55-60-65 Hz			
Scaling on 90° and 240° pointer types	45-50-55 Hz, 55-60-55 Hz, 45-55-65 Hz			

Connection Diagrams

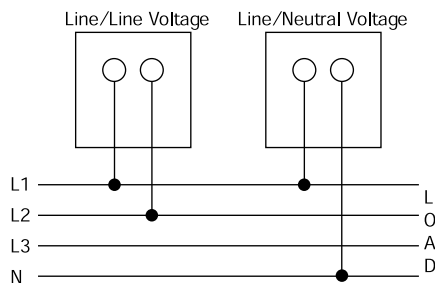

Order data/examples

Pointer type 90°

- 1) Select type: M244-41S-S,
- 2) Specify input voltage: 400V,
- 3) Specify frequency: 45/55 Hz,
- 4) Specify scaling: 45-50-55 Hz

Pointer type 240°

- 1) Select type: M244-41L-S,
- 2) Specify input voltage: 57-110V,
- 3) Specify frequency: 45/65 Hz,
- 4) Specify scaling: 45-55-65 Hz

Reed type 13 reeds

- 1) Select type: M244-41R-S,
- 2) Specify input voltage: 230V,
- 3) Specify frequency: 47/53 Hz,
- 4) Specify scaling: 47-50-53 Hz

Reed type 21 reeds

- 1) Select type: M244-41R-S,
- 2) Specify input voltage: 110V,
- 3) Specify frequency: 55/65 Hz,
- 4) Specify scaling: 55-60-65 Hz

PHASE SEQUENCE INDICATOR



Features

- Determines phase sequence in a 3-phase network
- Glow bulbs indicate L1, L2, L3 phase sequence

Benefits

- Easy to operate
- Terminal cover included

Applications

- AC switchgears, panels and distribution boards
- Control board
- Generator sets

Standards

- CE marked
- BV approved

General Specification

- Standard input ranges - 200-500 V, 50/60 Hz

Product Codes

Bezel size (mm)	96	-	-	-
Scale length (mm)	-	-	-	-
Phase sequence indicator	M244-12P-S	-	-	-

Order data/examples

Phase sequence indicator

- 1) Select type: M244-12P-S,
- 2) Specify input voltage: 200-500V,
- 3) Specify frequency: 50 or 60 Hz

Connection Diagrams

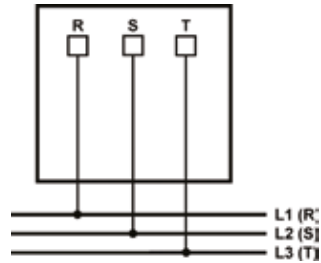

DUAL VOLTMETER AND FREQUENCY METER



Features

- Measures AC frequencies of two independent systems
- Pointer type dual voltmeter and frequency meter with two independent 90° short scale movements
- Reed type available with two independent measuring circuits - 21 reeds (45-55 Hz, 55-65 Hz)
- Direct or VT connected

Benefits

- Easy to operate
- High visibility
- Terminal cover included

Applications

- AC switchgears, panels and distribution boards
- Control board
- Generator sets

Construction

- Pointer type contains internal transducer, powered from input voltage and moving coil meter
- Reed type uses steel reeds in an electromagnetic field. Reeds are calibrated to its individual frequency to vibrate in resonance with the electromagnet and vibrates at full amplitude
- Slot in screw fixing

Standards

- CE marked
- BV approved

General Specification

- Accuracy class dual voltmeter - 1.5
- Accuracy class dual frequency meter - pointer type - 1
- Accuracy class dual frequency meter - reed type - 0.5
- Overload - 10xIn - 9x0.5s+1x5s/60s
- Dual voltmeter - 2xUn - 9x0.5s+1x5s/60s
- Dual frequency meter - pointer type - 1.2 x Un continuously, 1.5 x Un for 2 hours (pointer type only)
- Dual frequency meter - reed type - 2 x Un for 5 seconds
- Burden frequency meter - pointer type - 1 VA at nominal voltage 57-110 V and 230 V - 1.7 VA at nominal voltage 400V - 2 VA at nominal voltage 500V
- Burden frequency meter - reed type - 0.7 ... 1.2 VA at nominal voltage 110-230 V - 1.4 ... 2 VA at all other nominal voltages

Product Codes

Bezel size (mm)	96	96	96	-
Scale length (mm)	41	41	-	-
Voltmeter meter 2 x 90°	M244-80L-S	-	-	-
Frequency meter 2 x 90°	-	M244-41D-S	-	-
Frequency meter 2 x 21 reeds	-	-	M244-41E-S	-

Standard input ranges

Dual voltmeter (direct connected)	300V, 500V
Dual voltmeter (VT connected)	120V (for use with VT's x/100V), 132V (for use with VT's x/110V), 144V (for use with VT's 120V), 125V, 137.5V, 150V (for use with some VT's having primary voltage less than 1kV)
Dual frequency meter - pointer type	57-110 V, 400V +/- 20%, 500V +/-20%
Dual frequency meter - reed type	100V, 110V, 230V, 400V +/- 20%, 500V +/-20%

Scaling

Dual voltmeter	Specify to suit application
Dual frequency meter - pointer type	45-50-55 Hz, 55-60-55 Hz, 45-55-65 Hz
Dual frequency meter - reed type	45-50-55 Hz, 55-60-65 Hz

Connection Diagrams

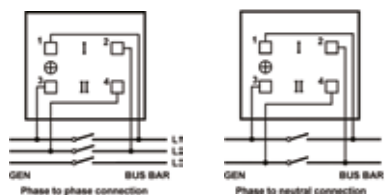

Order data/examples

Dual voltmeter - LV direct connected

- 1) Select type: M244-80L-S,
- 2) Specify input voltage: 500V,
- 3) Specify scaling: 0-500V,
- 4) Specify frequency: 50 Hz

Dual voltmeter - VT connected

- 1) Select type: M244-80L-S,
- 2) Specify input: 0-120V,
- 3) Specify scaling: 0-12kV,
- 4) Specify frequency: 50Hz,
- 5) Specify VT ratio: 10/0.1 kV

Dual frequency meter - pointer type

- 1) Select type: M244-41D-S,
- 2) Specify input voltage: 400V,
- 3) Specify frequency: 45/65 Hz,
- 4) Specify scaling: 45-55-65 Hz

Dual frequency meter - reed type

- 1) Select type: M244-41E-S,
- 2) Specify input voltage: 110V,
- 3) Specify frequency: 55/65 Hz,
- 4) Specify scaling: 55-60-65 Hz

POWER FACTOR METERS



Features

- Indicates Power factor of electrical systems
- Several voltage ranges available
- Current connection via “through hole” CT on the instrument. No need to interrupt wiring from CT

Benefits

- Easy to operate
- High visibility
- Terminal cover included
- Low self consumption
- Internal power supply from voltage input

Applications

- AC switchgears, panels and distribution boards
- Control boards
- Generator sets

Construction

- Instruments operate on a fast sampling method of input quantities (current and voltage) of the connected phases
- Meters include “through hole” CT connection, voltage dividers, internal microprocessor and power supply unit
- Slot in screw fixing

Standards

- CE marked
- BV approved

Order data/examples

Single-phase

- 1) Select type: M244-420-S,
- 2) Specify input voltage and current: 230V L-N/5A,
- 3) Specify scaling: 0.5/1/0.5 CAP/IND
- 4) Specify frequency: 50/60 Hz,

3-phase 4-wire balanced

- 1) Select type: M244-13D-S,
- 2) Specify input voltage and current: 69.3V L-N/1A,
- 3) Specify scaling: 0.5/1/0.5 CAP/IND,
- 4) Specify frequency: 50/60 Hz

General Specification

- Accuracy class - 1.5
- Maximum continuous overload - 3 x In, 1.5 x Un
- Maximum short duration overload - 25 x In for 30 seconds, 50 x In for 1 second, 2 x Un for 10 seconds
- Voltage burden - <0.1VA per phase
- Current burden - <0.1VA per phase
- Frequency - 50/60 Hz

Product Codes

Bezel size (mm)	96	96	96	96	96
Scale length (mm)	95	95	95	95	95
Power factor meter 90°	M244-420-S Single-phase	M244-421-S 3P/3W balanced	M244-42C-S 3P/4W balanced	M244-423-S 3P/3W unbalanced	M244-424-S 3P/4W unbalanced
Bezel size (mm)	96	96	96	96	96
Scale Length (mm)	135	135	135	135	135
Power factor meter 240°	M244-135-S Single-phase	M244-136-S 3P/3W balanced	M244-13D-S 3P/4W balanced	M244-138-S 3P/3W unbalanced	M244-139-S 3P/4W unbalanced
Standard input ranges					
Single-phase, 3P/4W balanced, 3P/4W unbalanced	57.7V L-N/1A, 57.7V L-N/5A, 63.5V L-N/1A, 63.5V L-N/5A, 69.3V L-N/1A, 9.3V L-N/5A, 230V L-N/1A, 230V L-N/5A, 240V L-N/1A, 240V L-N/5A, 254V L-N/1A, 254V L-N/5A,				
3P/3W balanced, 3P/3W unbalanced	100V L-L/1A, 100V L-L/5A, 110V L-L/1A, 110V L-L/5A, 400V L-L/1A, 400V L-L/5A, 415V L-L/1A, 415V L-L/5A, 440V L-L/1A, 440V L-L/5A				
Scaling	0.5/1/0.5 CAP/IND or 0.8/1/0.2 CAP/IND				

Connection Diagrams

Single-phase

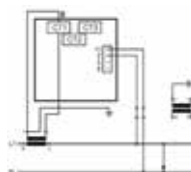

3-phase 4-wire (3P/4W) balanced

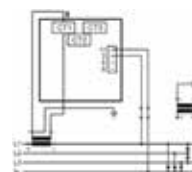

3-phase 4-wire (3P/4W) unbalanced

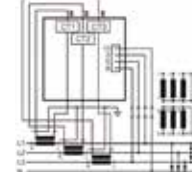

3-phase 3-wire (3P/3W) balanced

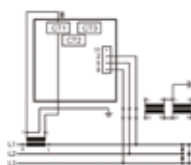

3-phase 3-wire (3P/4W) unbalanced

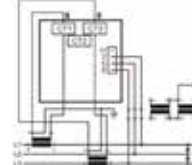

3-phase 4-wire unbalanced

- 1) Select type: M244-424-S,
- 2) Specify input voltage and current: 230V L-N/5A,
- 3) Specify scaling: 0.8/1/0.2 CAP/IND
- 4) Specify frequency: 50/60 Hz

3-phase 3-wire balanced

- 1) Select type: M244-136-S,
- 2) Specify input voltage and current: 110V L-L/5A,
- 3) Specify scaling: 0.5/1/0.5 CAP/IND,
- 4) Specify frequency: 50/60 Hz

3-phase 3-wire unbalanced

- 1) Select type: M244-138-S,
- 2) Specify input voltage and current: 415V L-L/1A,
- 3) Specify scaling: 0.5/1/0.5 CAP/IND,
- 4) Specify frequency: 50/60 Hz

WATTMETERS



Features

- Indicates active power of electrical systems
- Several voltage ranges available
- Current connection via “through hole” CT on the instrument. No need to interrupt wiring from CT

Benefits

- Easy to operate
- High visibility
- Terminal cover included
- Low self consumption
- Internal power supply from voltage input

Applications

- AC switchgears, panels and distribution boards
- Control boards
- Generator sets

Construction

- Instruments operate on a fast sampling method of input quantities (current and voltage) of the connected phases
- Meters include “through hole” CT connection, voltage dividers, internal microprocessor and power supply unit
- Slot in screw fixing

Standards

- CE marked
- BV approved

Order data/examples

Single-phase

- 1) Select type: M244-210-S,
- 2) Specify input voltage and CT ratio: 230V L-N, 50/5A,
- 3) Specify scaling: 0-10 kW,
- 4) Specify frequency: 50/60 Hz,

3-phase 4-wire balanced or 3-phase 4-wire unbalanced

- 1) Select type: M244-21D-S,
- 2) Specify input voltage and CT ratio: 230 V L-N, 400/5A,
- 3) Specify scaling: 0-250 kW,
- 4) Specify frequency: 50/60 Hz

General Specification

- Accuracy class - 1.5
- Maximum continuous overload - 3 x In, 1.5 x Un
- Maximum short duration overload - 25 x In for 30 seconds, 50 x In for 1 second, 2 x Un for 10 seconds
- Voltage burden - <0.1VA per phase
- Current burden - <0.1VA per phase
- Frequency - 50/60 Hz

Product Codes

Bezel size (mm)	96	96	96	96	96
Scale length (mm)	95	95	95	95	95
Wattmeter 90°	M244-210-S Single-phase	M244-211-S 3P/3W balanced	M244-21C-S 3P/4W balanced	M244-213-S 3P/3W unbalanced	M244-214-S 3P/4W unbalanced
Bezel size (mm)	96	96	96	96	96
Scale Length (mm)	135	135	135	135	135
Wattmeter 240°	M244-215-S Single-phase	M244-216-S 3P/3W balanced	M244-21D-S 3P/4W balanced	M244-218-S 3P/3W unbalanced	M244-219-S 3P/4W unbalanced
Standard input ranges					
Single-phase, 3P/4W balanced, 3P/4W unbalanced	57.7V L-N/1A, 57.7V L-N/5A, 63.5V L-N/1A, 63.5V L-N/5A, 230V L-N/1A, 230V L-N/5A, 240V -N/1A, 240V L-N/5A, 254V L-N/1A, 254V L-N/5A,				
3P/3W balanced, 3P/3W unbalanced	100V L-L/1A, 100V L-L/5A, 110V L-L/1A, 110V L-L/5A, 400V L-L/1A, 400V L-L/5A, 415V L-L/1A, 415V L-L/5A, 440V L-L/1A, 440V L-L/5A				

Calculation of end scale value

End scale value is calculated using the formula below, where correct voltage must be selected (either L-N or L-L), depending on the electrical system and the type of meter used. Scale factor, e.g. the relation between end scale value and nominal apparent power (cos-phi = 1) must be between 0.6 to 1.2. It is recommended selecting the scale value from 1 - 1.2 - 1.25 - 1.5 - 2 - 2.5 - 3 - 4 - 5 - 6 - 7.5 - 8 (and their decades) closest to the calculated result..

Electrical system	Formula	Example	End scale value to choose (considering 0,6 to 1.2 x S)
Single-phase, direct voltage connection	$P = U(L-N) \times I_p \times \cos \phi$	$P = 230V \times 50A \times 0.9 = 10350 W = 10.35 kW$	10 kW
3-phase 4-wire, direct voltage connection (balanced or unbalanced)	$P = 3 \times U(L-N) \times I_p \times \cos \phi$	$P = 3 \times 230V \times 400A \times 0.95 = 262200 W = 262,2 kW$	250 kW
3-phase 3-wire, direct voltage connection (balanced or unbalanced)	$P = 1.732 \times U(L-L) \times I_p \times \cos \phi$	$P = 1.732 \times 400V \times 1000A \times 0.9 = 623520 W = 623,52 kW$	600 kW
3-phase 4-wire, voltage connection via VT (balanced or unbalanced)	$P = 3 \times U_p(L-N) \times I_p \times \cos \phi$	$P = 3 \times 5770V \times 100A \times 0.95 = 1644450 W = 1,64445 MW$	1.5 MW
3-phase 3-wire, voltage connection via VT (balanced or unbalanced)	$P = 1.732 \times U_p(L-L) \times I_p \times \cos \phi$	$P = 1.732 \times 30000V \times 50A \times 0.9 = 2338200 W = 2,3382 MW$	2,5 MW

3-phase 3-wire balanced or unbalanced

- 1) Select type: M244-213-S,
- 2) Specify input voltage and CT ratio: 400V L-L, 1000/1A,
- 3) Specify scaling: 0-600 kW,
- 4) Specify frequency: 50/60 Hz

3-phase 4-wire balanced or unbalanced, VT connected

- 1) Select type: M244-214-S,
- 2) Specify VT ratio and CT ratio: 5770/57.7V L-N, 100/5A,
- 3) Specify scaling: 0-1.5 MW,
- 4) Specify frequency: 50/60 Hz

3-phase 3-wire balanced or unbalanced

- 1) Select type: M244-218-S,
- 2) Specify input VT ratio and CT ratio: 30000/110V L-L, 50/1A,
- 3) Specify scaling: 0-2.5 MW
- 4) Specify frequency: 50/60 Hz

VARMETERS



Features

- Indicates reactive power of electrical systems
- Several voltage ranges available
- Current connection via “through hole” CT on the instrument. No need to interrupt wiring from CT.

Benefits

- Easy to operate
- High visibility
- Terminal cover included
- Low self consumption
- Internal power supply from voltage input

Applications

- AC switchgears, panels and distribution boards
- Control boards
- Generator sets

Construction

- Instruments operate on a fast sampling method of input quantities (current and voltage) of the connected phases.
- Meters include “through hole” CT connection, voltage dividers, internal microprocessor and power supply unit.
- Slot in screw fixing

Standards

- CE marked
- BV approved

Order data/examples

Single-phase

- 1) Select type: M244-310-S,
- 2) Specify input voltage and CT ratio: 230V L-N, 50/5A,
- 3) Specify scaling: 0-6 kvar,
- 4) Specify frequency: 50/60 Hz,

3-phase 4-wire balanced or 3-phase 4-wire unbalanced

- 1) Select type: M244-31D-S,
- 2) Specify input voltage and CT ratio: 230 V L-N, 400/5A,
- 3) Specify scaling: 0-200 kvar,
- 4) Specify frequency: 50/60 Hz

General Specification

- Accuracy class - 1.5
- Maximum continuous overload - 3 x In, 1.5 x Un
- Maximum short duration overload - 25 x In for 30 seconds, 50 x In for 1 second, 2 x Un for 10 seconds
- Voltage burden - <0.1VA per phase
- Current burden - <0.1VA per phase
- Frequency - 50/60 Hz

Product Codes

Bezel size (mm)	96	96	96	96	96
Scale Length (mm)	95	95	95	95	95
Varmeter 90°	M244-310-S Single-phase	M244-311-S 3P/3W balanced	M244-31C-S 3P/4W balanced	M244-313-S 3P/3W unbalanced	M244-314-S 3P/4W unbalanced
Bezel size (mm)	96	96	96	96	96
Scale length (mm)	135	135	135	135	135
Varmeter 240°	M244-315-S Single-phase	M244-316-S 3P/3W balanced	M244-31D-S 3P/4W balanced	M244-318-S 3P/3W unbalanced	M244-319-S 3P/4W unbalanced
Standard input ranges					
Single-phase, 3P/4W balanced, 3P/4W unbalanced	57.7V L-N/1A, 57.7V L-N/5A, 63.5V L-N/1A, 63.5V L-N/5A, 230V L-N/1A, 230V L-N/5A, 240V L-N/1A, 240V L-N/5A, 254V L-N/1A, 254V L-N/5A,				
3P/3W balanced, 3P/3W unbalanced	100V L-L/1A, 100V L-L/5A, 110V L-L/1A, 110V L-L/5A, 400V L-L/1A, 400V L-L/5A, 415V L-L/1A, 415V L-L/5A, 440V L-L/1A, 440V L-L/5A				

Calculation of end scale value

End scale value is calculated using the formula below, where correct voltage must be selected (either L-N or L-L), depending on the electrical system and the type of meter used. Scale factor, e.g. the relation between end scale value and nominal apparent power (cos-phi = 1) must be between 0.6 to 1.2. It is recommended selecting the scale value from 1 - 1.2 - 1.25 - 1.5 - 2 - 2.5 - 3 - 4 - 5 - 6 - 7.5 - 8 (and their decades) closest to the calculated result.

I_p = CT primary current, U_p = VT primary voltage, U = direct connected voltage, $\sin \phi$ = power factor

Electrical system	Formula	Example	End scale value to choose (considering 0,6 to 1.2 x S)
Single-phase, direct voltage connection	$Q = U(L-N) \times I_p \times \sin \phi$	$Q = 230V \times 50A \times 0.44 = 5060 \text{ var} = 5,06 \text{ kvar}$	6 kvar
3-phase 4-wire, direct voltage connection (balanced or unbalanced)	$Q = 3 \times U(L-N) \times I_p \times \sin \phi$	$P = 3 \times 230V \times 400A \times 0.31 = 85560 \text{ var} = 85,56 \text{ kvar}$	200 kvar
3-phase 3-wire, direct voltage connection (balanced or unbalanced)	$Q = 1.732 \times U(L-L) \times I_p \times \sin \phi$	$P = 1.732 \times 400V \times 1000A \times 0.44 = 304832 \text{ var} = 304,8 \text{ kvar}$	500 kvar
3-phase 4-wire, voltage connection via VT (balanced or unbalanced)	$Q = 3 \times U_p(L-N) \times I_p \times \sin \phi$	$P = 3 \times 5770V \times 100A \times 0.199 = 344469 \text{ var} = 344,469 \text{ kvar}$	1 Mvar
3-phase 3-wire, voltage connection via VT (balanced or unbalanced)	$Q = 1.732 \times U_p(L-L) \times I_p \times \sin \phi$	$P = 1.732 \times 30000V \times 50A \times 0.44 = 1143120 \text{ var} = 1,14312 \text{ Mvar}$	2 Mvar

3-phase 3-wire balanced or unbalanced

- 1) Select type: M244-313-S,
- 2) Specify input voltage and CT ratio: 400V L-L, 1000/1A,
- 3) Specify scaling: 0-500 kvar,
- 4) Specify frequency: 50/60 Hz

3-phase 4-wire balanced or unbalanced, VT connected

- 1) Select type: M244-314-S,
- 2) Specify VT ratio and CT ratio: 5770/57.7V L-N, 100/5A,
- 3) Specify scaling: 0-1 Mvar,
- 4) Specify frequency: 50/60 Hz

3-phase 3-wire balanced or unbalanced

- 1) Select type: M244-318-S,
- 2) Specify input VT ratio and CT ratio: 30000/110V L-L, 50/1A,
- 3) Specify scaling: 0-2 Mvar,
- 4) Specify frequency: 50/60 Hz



Wiring Diagrams of Wattmeters and Varmeters

Single-phase, direct or VT voltage connection

Wattmeter M244-210-S
Wattmeter M244-215-S
Varmeter M244-310-S
Varmeter M244-315-S

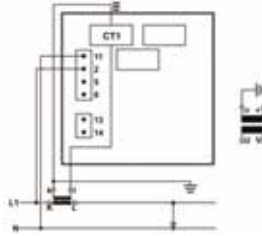

3-phase 3-wire balanced, direct or VT voltage connection

Wattmeter M244-211-S
Wattmeter M244-216-S
Varmeter M244-311-S
Varmeter M244-316-S

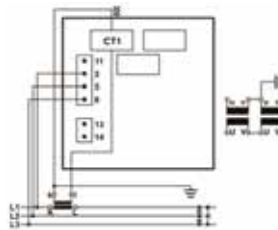

3-phase 4-wire balanced, direct or VT voltage

Wattmeter M244-21C-S
Wattmeter M244-21D-S
Varmeter M244-31C-S
Varmeter M244-31D-S

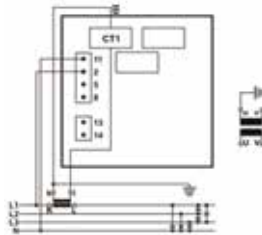

3-phase 3-wire unbalanced, direct or VT voltage connection

Wattmeter M244-213-S
Wattmeter M244-218-S
Varmeter M244-313-S
Varmeter M244-318-S

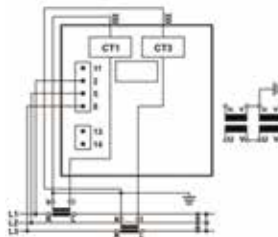

3-phase 4-wire unbalanced, direct or VT voltage connection

Wattmeter M244-214-S
Wattmeter M244-219-S
Varmeter M244-314-S
Varmeter M244-319-S

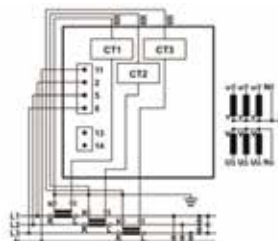

ACTIVE ENERGY METER WITH POWER INDICATOR



Features

- Counts electrical active energy and indicates active power of electrical systems
- Several voltage ranges available
- Current connection via “through hole” CT on the instrument. No need to interrupt wiring from CT
- Pulsed output as standard

Benefits

- High visibility
- Terminal cover included
- Low self consumption
- Separated power supply

Applications

- AC switchgears, panels and distribution boards
- Control boards
- Generator sets

Construction

- Instruments operate on a fast sampling method of input quantities (current and voltage) of the connected phases
- Meters include “through hole” CT connection, voltage dividers, internal microprocessor and power supply unit
- Slot in screw fixing

Standards

- CE marked
- BV approved

Order data/examples

Single-phase

- Select type: M244-HWG-S,
- Specify input voltage and CT ratio: 230V L-N, 50/5A,
- Spec. scaling: 0-10 kW,
- Spec. frequency: 50/60 Hz,
- Select pulse rate: 1p/10kWh,
- Select output: 1 pulsed output

3-phase 4-wire balanced or 3-phase 4-wire unbalanced

- Select type: M244-HWK-S,
- Specify input voltage and CT ratio: 230 V L-N, 400/5A,
- Spec. scaling: 0-250 kW,
- Spec. frequency: 50/60 Hz,

General Specification

- Accuracy class active power meter - 1.5
- Accuracy class active energy meter - 1 to EN 62053-21
- Maximum continuous overload - $2 \times I_n, 1.2 \times U_n$
- Nominal frequency - 50/60 Hz
- Voltage burden - $<0.1V_A$ per phase
- Current burden - $<0.1I_A$ per phase
- Power supply - 20-300 VDC/48-276 VAC
- Frequency - 40-65 Hz
- Voltage burden - $<3 V_A$
- Pulsed output - 1 SO pulsed output with 1p/10kWh, 1p/100kWh, 1p/10MWh, 1p/100MWh. Maximum pulse rate may not exceed 33 pulses per second (1980 pulses per minute). If in doubt choose next higher value, e.g. 1p/100/kWh instead of 1p/10kWh

Product Codes

Bezel size (mm)	96	96	96	96	96
Scale length (mm)	95	95	95	95	95
Active energy meter with Wattmeter 90°	M244-HWG-S Single-phase	M244-HWH-S 3P/3W balanced	M244-HWV-S 3P/4W balanced	M244-HWJ-S 3P/3W unbalanced	M244-HWK-S 3P/4W unbalanced
Bezel size (mm)	96	96	96	96	96
Scale Length (mm)	135	135	135	135	135
Active energy meter with Wattmeter 240°	M244-HWB-S Single-phase	M244-HWC-S 3P/3W balanced	M244-HWU-S 3P/4W balanced	M244-HWD-S 3P/3W unbalanced	M244-HWE-S 3P/4W unbalanced
Standard input ranges					
Single-phase, 3P/4W balanced & unbalanced	57.7V L-N/1A, 57.7V L-N/5A, 63.5V L-N/1A, 63.5V L-N/5A, 230V L-N/1A, 230V L-N/5A, 240V L-N/1A, 240V L-N/5A, 254V L-N/1A, 254V L-N/5A,				
3P/3W balanced & unbalanced	1100V L-L/1A, 100V L-L/5A, 110V L-L/1A, 110V L-L/5A, 400V L-L/1A, 400V L-L/5A, 415V L-L/1A, 415V L-L/5A, 440V L-L/1A, 440V L-L/5A				

Calculation of end scale value

End scale value is calculated using the formula below, where correct voltage must be selected (either L-N or L-L), depending on the electrical system and the type of meter used. Scale factor, e.g. the relation between end scale value and nominal apparent power ($\cos\phi = 1$) must be between 0.6 to 1.2. It is recommended selecting the scale value from 1 - 1.2 - 1.25 - 1.5 - 2 - 2.5 - 3 - 4 - 5 - 6 - 7.5 - 8 (and their decades) closest to the calculated result.

I_p = CT primary current, U_p = VT primary voltage, U = direct connected voltage, $\cos\phi$ = power factor

Electrical system	Formula	Example	End scale value to choose (considering 0.6 to 1.2 x S)
Single-phase, direct voltage connection	$P = U(L-N) \times I_p \times \cos\phi$	$P = 230V \times 50A \times 0.9 = 10350 W = 10.35 kW$	10 kW
3-phase 4-wire, direct voltage connection (balanced or unbalanced)	$P = 3 \times U(L-N) \times I_p \times \cos\phi$	$P = 3 \times 230V \times 400A \times 0.95 = 262200 W = 262.2 kW$	250 kW
3-phase 3-wire, direct voltage connection (balanced or unbalanced)	$P = 1.732 \times U(L-L) \times I_p \times \cos\phi$	$P = 1.732 \times 400V \times 1000A \times 0.9 = 623520 W = 623.52 kW$	600 kW
3-phase 4-wire, voltage connection via VT (balanced or unbalanced)	$P = 3 \times U_p(L-N) \times I_p \times \cos\phi$	$P = 3 \times 5770V \times 100A \times 0.95 = 1644450 W = 1.64445 MW$	1.5 MW
3-phase 3-wire, voltage connection via VT (balanced or unbalanced)	$P = 1.732 \times U_p(L-L) \times I_p \times \cos\phi$	$P = 1.732 \times 30000V \times 50A \times 0.9 = 2338200 W = 2.3382 MW$	2,5 MW

- Select pulse rate: 1p/10kWh,
- Select output: 1 puls. o/p

3-phase 3-wire balanced or unbalanced

- Select type: M244-HWJ-S,
- Specify input voltage and CT ratio: 400V L-L, 1000/1A,
- Spec. scaling: 0-600 kW,
- Spec. frequency: 50/60 Hz ,
- Select pulse rate: 1p/10kWh,
- Select output: 1 puls. o/p

3-phase 4-wire balanced or unbalanced, VT connected

- Select type: M244-HWU-S,

- Specify VT ratio and CT ratio: 5770/57.7V L-N, 100/5A,
- Spec. scaling: 0-1.5 MW,
- Spec. frequency: 50/60 Hz,
- Select pulse rate: 1p/100kWh,
- Select output: 1 pulsed output

3-phase 3-wire balanced or unbalanced

- Select type: M244-HWD-S,
- Specify input VT ratio and CT ratio: 30000/110V L-L, 50/1A,
- Spec. scaling: 0-2.5MW
- Spec. frequency: 50/60 Hz,
- Select pulse rate: 1p/100kWh,
- Select output: 1 pulsed output

REACTIVE ENERGY METER WITH POWER INDICATOR



Features

- Counts electrical reactive energy and indicates reactive power of electrical systems
- Several voltage ranges available
- Current connection via "through hole" CT on the instrument. No need to interrupt wiring from CT
- Pulsed output as standard

Benefits

- High visibility
- Terminal cover included
- Low self consumption
- Separated power supply

Applications

- AC switchgears, panels and distribution boards
- Control boards
- Generator sets

Construction

- Instruments operate on a fast sampling method of input quantities (current and voltage) of the connected phases
- Meters include "through hole" CT connection, voltage dividers, internal microprocessor and power supply unit
- Slot in screw fixing

Standards

- CE marked
- BV approved

Order data/examples

Single-phase

- Select type: M244-HXG-S,
- Specify input voltage and CT ratio: 230V L-N, 50/5A,
- Spec. scaling: 0-6kvar,
- Spec. frequency: 50/60 Hz,
- Select pulse rate: 1p/10kvarh,
- Select output: 1 pulsed output

3-phase 4-wire balanced or

- Select type: M244-HXK-S,
- Specify input voltage and CT ratio: 230 V L-N, 400/5A,
- Spec. scaling: 0-200kvar,

General Specification

- Accuracy class reactive power meter - 1.5
- Accuracy class reactive energy meter - 2 to EN 62053-23
- Maximum continuous overload - $2 \times I_n$, $1.2 \times U_n$
- Nominal frequency - 50/60 Hz
- Voltage burden - $<0.1VA$ per phase
- Current burden - $<0.1VA$ per phase
- Power supply - 20-300 VDC / 48-276 VAC
- Frequency - 40-65 Hz
- Voltage burden - $<3 VA$
- Pulsed output - 1 SO pulsed output with 1p/10kWh, 1p/100kWh, 1p/10MWh, 1p/100MWh. Maximum pulse rate may not exceed 33 pulses per second (1980 pulses per minute). If in doubt choose next higher value, e.g. 1p/100/kWh instead of 1p/10kWh

Product Codes

Bezel size (mm)	96	96	96	96	96
Scale length (mm)	95	95	95	95	95
Reactive energy meter with Varmeter 90°	M244-HXG-S Single-phase	M244-HXH-S 3P/3W balanced	M244-HXV-S 3P/4W balanced	M244-HXJ-S 3P/3W unbalanced	M244-HXK-S 3P/4W unbalanced
Bezel size (mm)	96	96	96	96	96
Scale Length (mm)	135	135	135	135	135
Reactive energy meter with Varmeter 240°	M244-HXB-S Single-phase	M244-HXC-S 3P/3W balanced	M244-HXU-S 3P/4W balanced	M244-HXD-S 3P/3W unbalanced	M244-HXE-S 3P/4W unbalanced
Standard input ranges					
Single-phase, 3P/4W balanced & unbalanced	57.7V L-N/1A, 57.7V L-N/5A, 63.5V L-N/1A, 63.5V L-N/5A, 230V L-N/1A, 230V L-N/5A, 240V L-N/1A, 240V L-N/5A, 254V L-N/1A, 254V L-N/5A,				
3P/3W balanced & unbalanced	100V L-L/1A, 100V L-L/5A, 110V L-L/1A, 110V L-L/5A, 400V L-L/1A, 400V L-L/5A, 415V L-L/1A, 415V L-L/5A, 440V L-L/1A, 440V L-L/5A				

Calculation of end scale value

End scale value is calculated using the formula below, where correct voltage must be selected (either L-N or L-L), depending on the electrical system and the type of meter used. Scale factor, e.g. the relation between end scale value and nominal apparent power ($\cos\phi = 1$) must be between 0.6 to 1.2. It is recommended selecting the scale value from 1 - 1.2 - 1.25 - 1.5 - 2 - 2.5 - 3 - 4 - 5 - 6 - 7.5 - 8 (and their decades) closest to the calculated result..

I_p = CT primary current, U_p = VT primary voltage, U = direct connected voltage, $\sin \phi$ = power factor

Electrical system	Formula	Example	End scale value to choose (considering 0,6 to 1.2 x S)
Single-phase, direct voltage connection	$P = U(L-N) \times I_p \times \sin \phi$	$Q = 230V \times 50A \times 0.44 = 5060 \text{ var} = 5.06 \text{ kvar}$	6 kvar
3-phase 4-wire, direct voltage connection (balanced or unbalanced)	$P = 3 \times U(L-N) \times I_p \times \sin \phi$	$P = 3 \times 230V \times 400A \times 0.31 = 85560 \text{ var} = 85.56 \text{ kvar}$	200 kvar
3-phase 3-wire, direct voltage connection (balanced or unbalanced)	$P = 1.732 \times U(L-L) \times I_p \times \sin \phi$	$P = 1.732 \times 400V \times 1000A \times 0.44 = 304832 \text{ var} = 304.8 \text{ kvar}$	500 kvar
3-phase 4-wire, voltage connection via VT (balanced or unbalanced)	$P = 3 \times U_p(L-N) \times I_p \times \sin \phi$	$P = 3 \times 5770V \times 100A \times 0.199 = 344469 \text{ var} = 344.469 \text{ kvar}$	1 Mvar
3-phase 3-wire, voltage connection via VT (balanced or unbalanced)	$P = 1.732 \times U_p(L-L) \times I_p \times \sin \phi$	$P = 1.732 \times 30000V \times 50A \times 0.44 = 1143120 \text{ var} = 1.14312 \text{ Mvar}$	2 Mvar

- Spec. frequency: 50/60 Hz,
- Spec. pulse rate: 1p/10kvarh,
- Select output: 1 pul. O/P

3-phase 3-wire balanced or unbalanced

- Select type: M244-HXJ-S,
- Spec. input voltage and CT ratio: 400V L-L, 1000/1A,
- Spec. scaling: 0-500 kvar,
- Spec. frequency: 50/60 Hz,
- Select pulse rate: 1p/10kvarh,
- Select output: 1 pul. O/P

3-phase 4-wire balanced or unbalanced, VT connected

- Select type: M244-HXU-S,

- Specify VT ratio and CT ratio: 5770/57.7V L-N, 100/5A,

- Spec. scaling: 0-1 Mvar,
- Spec. frequency: 50/60 Hz,
- Select pulse rate: 1p/100kvarh,
- Select output: 1 pul. O/P

3-phase 3-wire balanced or unbalanced

- Select type: M244-HXD-S,
- Specify input VT ratio and CT ratio: 30000/110V L-L, 50/1A,
- Spec. scaling: 0-2 Mvar
- Spec. frequency: 50/60 Hz,
- Select pulse rate: 1p/100kWh,
- Select output: 1 pulsed O/P



Wiring Diagrams Energy Meters

Single-phase, direct or VT voltage connection

Active Energy Meter M244-HWG-S
Active Energy Meter M244-HWB-S
Reactive Energy Meter M244-HXG-S
Reactive Energy Meter M244-HXB-S

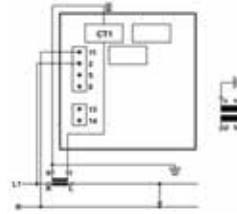

Power supply:
Terminal 13 and 14
Pulsed output:
Terminal 15 and 16

3-phase 3-wire balanced, direct or VT voltage connection

Active Energy Meter M244-HWH-S
Active Energy Meter M244-HWC-S
Reactive Energy Meter M244-HXH-S
Reactive Energy Meter M244-HXC-S

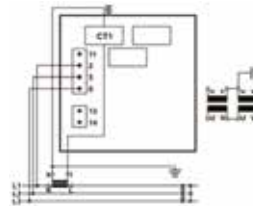

Power supply:
Terminal 13 and 14
Pulsed output:
Terminal 15 and 16

3-phase 4-wire balanced, direct or VT voltage connection

Active Energy Meter M244-HWV-S
Active Energy Meter M244-HWU-S
Reactive Energy Meter M244-HXV-S
Reactive Energy Meter M244-HXU-S

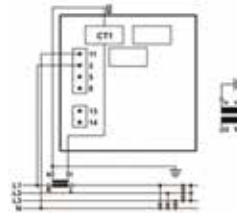

Power supply:
Terminal 13 and 14
Pulsed output:
Terminal 15 and 16

3-phase 3-wire unbalanced, direct or VT voltage connection

Active Energy Meter M244-HWJ-S
Active Energy Meter M244-HWD-S
Reactive Energy Meter M244-HXJ-S
Reactive Energy Meter M244-HXD-S

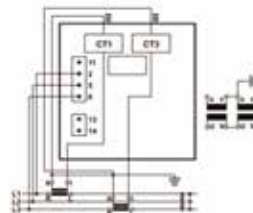

Power supply:
Terminal 13 and 14
Pulsed output:
Terminal 15 and 16

3-phase 4-wire unbalanced, direct or VT voltage connection

Active Energy Meter M244-HWK-S
Active Energy Meter M244-HWE-S
Reactive Energy Meter M244-HXK-S
Reactive Energy Meter M244-HXE-S

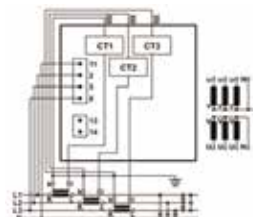

Power supply:
Terminal 13 and 14
Pulsed output:
Terminal 15 and 16

SYNCHROSCOPE



Features

- Typically used to measure between Busbar and Generator
- Available as LED indicator only, LED indicator with LCD display, LED indicator with synchro check relay, LED indicator with LCD display and synchro check relay

Benefits

- Supports damage prevention on expensive assets
- Simple synchronisation conditions setting
- High visibility
- Terminal cover included
- Low self consumption
- Up to five meters in one unit

Applications

- Used on manual and semi-automatic synchronising applications
- AC switchgears, panels and distribution boards
- Generator sets

Construction

- Instruments are microprocessor based
- Slot in screw fixing

Standards

- CE marked
- BV approved

General Specification

Synchronising functions

- Voltage difference setting (ΔU) - 1.5
- Accuracy - +/- 2.5%
- Phase difference setting - 2 ... 20° el.
- Accuracy - +/- 3° el.
- Time delay synchronisation - 0.1 ... 1 s.
- Accuracy - +/- 10%
- Synchronisation pulse duration - 300 ms
- Accuracy - +/- 30 ms
- Nominal frequency range - 45/65 Hz
- Output relay specification - 250V, 6A, 50 Hz, 1500 VA
- Voltage burden - <4 VA
- Overload - 1.2 x Un permanently, 2 x Un for 3s

LED functions

- Resolution $\Delta \varphi$ display - 20° el.
- Magnified resolution range - +/- 15° el.
- Magnified resolution - 5° el.
- Accuracy at $\Delta \varphi = 0$ - +/- 3° el.

LCD functions

- Accuracy voltage display - +/- 1.5%
- Accuracy frequency display - +/- 0.5%
- Phase difference accuracy Ugen to Ubb - +/- 3° el.

Product Codes

Bezel size (mm)	96	96	96
	M244-14A-S LED only	M244-14L-S LED & synchro check relay	M244-14D-S LED & synchro check relay with deadbus option
Bezel size (mm)	96	96	96
		M244-4M-S LED & synchro check relay & LCD	M244-14E-S LED & synchro check relay with deadbus option & LCD display
Standard input ranges			
Voltage	100V L/L, 110V L/L/400V L/L, 415 V L/L, 440V L/L		

Order data/examples

- 1) Select type: M244-14M-S,
- 2) Specify input voltage: 415V,
- 3) Specify display or output: Relay output,
- 4) Specify frequency: 45-65 Hz,
- 5) Specify functional description: Output duration 300ms

Connection Diagrams

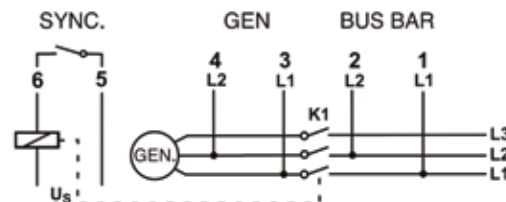

Product Dimensions

Description		M242-01*, M242-02*, M242-05*	M243-01*, M243-02*, M243-05*	M244-01*, M244-02*, M244-05*, M244-41R*, M244-41E*, M244-41L*, M244-41D*, M244-41S*, M244-80*, M244-12*	M246-01*, M246-02*, M246-05*
Bezel (mm)	a	48	72	96	144
Panel cut out (mm)	b	45 (+0.6)	68 (+0.8)	92 (+0.8)	138 (+1.0)
Bezel height (mm)	c	5.0	5.5	5.5	8.0
Terminal cover (mm)	d	42.5	66.5	90	90

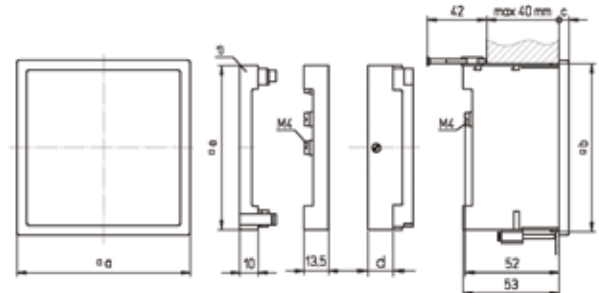
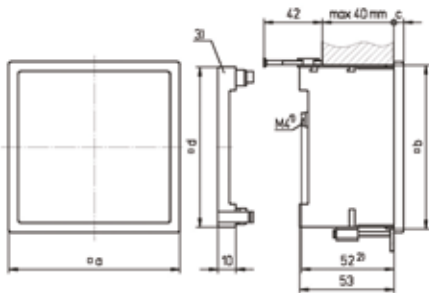

M242-01*, M242-02*, M242-05*, M243-01*, M243-02*,
M243-05*, M244-01*, M244-02*, M244-41R*, M244-41E*,
M244-05*, M244-12*, M246-01*, M246-02*, M246-05*

M244-41L*, M244-41D*, M244-41S*, M244-80*
(d = 27.3 mm)

2) 59 mm on current ratings 30 to 60A

Description		M244-13*, M244-42*, M244-21*, M244-31*	M244-HW*, M244-HX*	M244-14*
Bezel (mm)	a	96	96	96
Panel cut out (mm)	b	92 (+0.8)	92 (+0.8)	92 (+0.8)
Bezel height (mm)	c	5.5	5.5	5.5

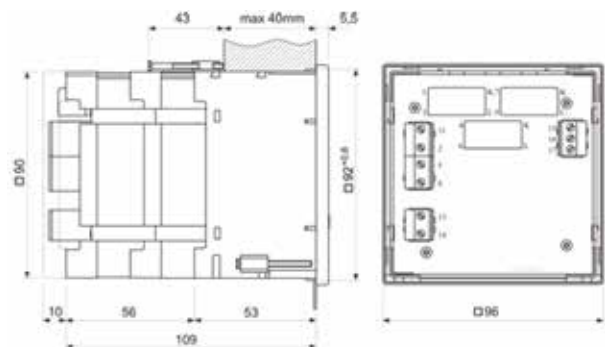
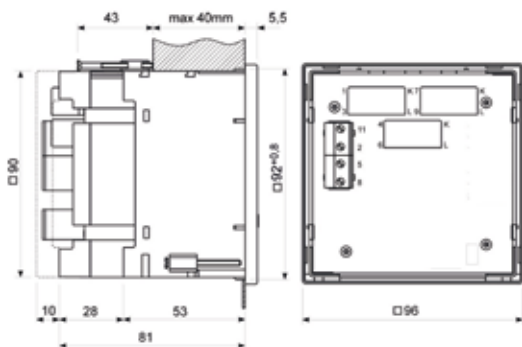

M244-13*, M244-42*, M244-21*, M244-31*

M244-HW*, M244-HX*

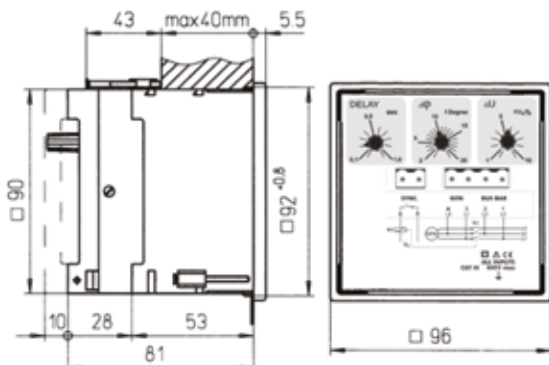

Technical Details

Type	M242-01* M242-02*	M243-01* M243-02*	M244-01* M244-02*	M246-01* M246-02*	M242-05*	M243-05*	M244-05*	M246-05*	M243-02Q*	M244-02E* M244-02Q*
Weight (kg)	0.14	0.18	0.2	0.4	0.15	0.19	0.25	0.39	0.22	0.32
Type	M244-1S* M244-1L*	M244-1R*	M244-1E* M244-41D*	M244-80*	M244-12*	M244-42*	M244-13*	M244-21* M244-31*	M244-HW* M244-HX*	M244-14*
Weight (kg)	0.4	0.4	0.5	0.5	0.4	0.5	0.7	0.5 (short scale) 0.7 (long scale)	0.6	0.53
Type	M242-01* M242-02*	M243-01* M243-02*	M244-01* M244-02*	M246-01* M246-02*	M242-05*	M243-05*	M244-05*	M246-05*	M243-02Q*	M244-02E* M244-02Q*
Materials (case /base)	Poly-carbonate, Grade UL94V0	Poly-carbonate, Grade UL94V0	Poly-carbonate, Grade UL94V0	Poly-carbonate, Grade UL94V0	Poly-carbonate, Grade UL94V0	Poly-carbonate, Grade UL94V0	Poly-carbonate, Grade UL94V0	Poly-carbonate, Grade UL94V0	Poly-carbonate, Grade UL94V0	Poly-carbonate, Grade UL94V0
Type	M244-41S* M244-41L*	M244-41R*	M244-41E* M244-41D*	M244-80*	M244-12*	M244-42*	M244-13*	M244-21* M244-31*	M244-HW* M244-HX*	M244-14*
Materials (case /base)	Poly-carbonate, Grade UL94V0	Poly-carbonate, Grade UL94V0	Poly-carbonate, Grade UL94V0	Poly-carbonate, Grade UL94V0	Poly-carbonate, Grade UL94V0	Poly-carbonate/ABS, Grade UL94V0	Poly-carbonate/ABS, Grade UL94V0	Poly-carbonate/ABS, Grade UL94V0	Poly-carbonate/ABS, Grade UL94V0	Poly-carbonate/ABS, Grade UL94V0
Type	M242-01* M242-02*	M243-01* M243-02*	M244-01* M244-02*	M246-01* M246-02*	M242-05*	M243-05*	M243-05* M244-05*	M246-05*	M243-02Q*	M244-02E* M244-02Q*
Temperature: Reference Range Stocking	+18/+28°C -25/+55°C -40/+70°C	+18/+28°C -25/+55°C -40/+70°C	+18/+28°C -25/+55°C -40/+70°C	+18/+28°C -25/+55°C -40/+70°C	+18/+28°C -25/+55°C -40/+70°C	+18/+28°C -25/+55°C -40/+70°C	+18/+28°C -25/+55°C -40/+70°C	+18/+28°C -25/+55°C -40/+70°C	+18/+28°C -25/+55°C -40/+70°C	+18/+28°C -25/+55°C -40/+70°C
Type	M244-41S* M244-41L*	M244-41R*	M244-41E* M244-41D*	M244-80*	M244-12*	M244-42*	M244-13*	M244-21* M244-31*	M244-HW* M244-HX*	M244-14*
Temperature: Reference Range Stocking	+18/+28°C -25/+55°C -40/+70°C	+18/+28°C -25/+55°C -40/+70°C	+18/+28°C -25/+55°C -40/+70°C	+18/+28°C -25/+55°C -40/+70°C	+18/+28°C -25/+55°C -40/+70°C	+18/+28°C -25/+55°C -40/+70°C	+18/+28°C -25/+55°C -40/+70°C	+23°C -10/+55°C -40/+70°C	+23°C -10/+55°C -40/+70°C	0/50°C -20/+55°C -40/+70°C
Type	M242-01* M242-02*	M243-01* M243-02*	M244-01* M244-02*	M246-01* M246-02*	M242-05*	M243-05*	M244-05*	M246-05*	M243-02Q*	M244-02E* M244-02Q*
Relative humidity (none condensing)	up to 80%	up to 80%	up to 80%	up to 80%	up to 80%	up to 80%	up to 80%	up to 80%	up to 80%	up to 80%
Type	M244-41S* M244-41L*	M244-41R*	M244-41E* M244-41D*	M244-80*	M244-12*	M244-42*	M244-13*	M244-21* M244-31*	M244-HW* M244-HX*	M244-14*
Relative humidity (none condensing)	up to 80%	up to 80%	up to 80%	up to 80%	up to 80%	up to 80%	up to 80%	up to 75%	up to 75%	up to 95%
Type	M242-01* M242-02*	M243-01* M243-02*	M244-01* M244-02*	M246-01* M246-02*	M242-05*	M243-05*	M244-05*	M246-05*	M243-02Q*	M244-02E* M244-02Q*
Terminals	M4	M4 (M6 from (15) 30 to 60A)	M4 (M6 from (15) 30 to 60A)	M4 (M6 from (15) 30 to 60A)	M4	M4	M4	M4	M4	M4
Type	M244-41S* M244-41L*	M244-41R*	M244-41E* M244-41D*	M244-80*	M244-12*	M244-42*	M244-13*	M244-21* M244-31*	M244-HW* M244-HX*	M244-14*
Terminals	M4	M4	M4	M4	M4	Volts: 2.5mm ² Amps: d = 6mm Other: 2.5mm ²	Volts: 2.5mm ² Amps: d = 6mm Other: 2.5mm ²	Volts: 2.5mm ² Amps: d = 6mm Other: 2.5mm ²	Volts: 2.5mm ² Amps: d = 6mm Other: 2.5mm ²	Volts: 2.5mm ² Amps: d = 6mm Other: 2.5mm ²
Type	M242-01* M242-02*	M243-01* M243-02*	M244-01* M244-02*	M246-01* M246-02*	M242-05*	M243-05*	M244-05*	M246-05*	M243-02Q*	M244-02E* M244-02Q*
IP front IP back **	IP 52 IP 00	IP 52 IP 00	IP 52 IP 00	IP 52 IP 00	IP 52 IP 00	IP 52 IP 00	IP 52 IP 00	IP 52 IP 00	IP 52 IP 00	IP 52 IP 00
Type	M244-41S* M244-41L*	M244-41R*	M244-41E* M244-41D*	M244-80*	M244-12*	M244-42*	M244-13*	M244-21* M244-31*	M244-HW* M244-HX*	M244-14*
IP front IP back **	IP 52 IP 00	IP 52 IP 00	IP 52 IP 00	IP 52 IP 00	IP 52 IP 00	IP 52 IP 00	IP 52 IP 00	IP 52 IP 00	IP 52 IP 00	IP 52 IP 00

* denotes an abbreviation of the catalogue number as shown on previous pages , ** without terminal cover

Technical Details

Type	M242-01* M242-02*	M243-01* M243-02*	M244-01* M244-02*	M246-01* M246-02*	M242-05*	M243-05*	M244-05*	M246-05*	M243-02Q*	M244-02E* M244-02Q*
Mounting position	Vertical	Vertical	Vertical	Vertical	Vertical	Vertical	Vertical	Vertical	Vertical	Vertical
Type	M244-41S* M244-41L*	M244-41R*	M244-41E* M244-41D*	M244-80*	M244-12*	M244-42*	M244-13*	M244-21* M244-31*	M244-HW* M244-HX*	M244-14*
Mounting position	Vertical	Vertical	Vertical	Vertical	Vertical	Vertical	Vertical	Vertical	Vertical	Vertical
Type	<p>M243-02*, M244-02*, M246-02*, M244-02Q*, M244-80L*, M244-12P*</p> <p>M242-01V*, M243-01V*, M244-01V*, M246-01V*, M242-05V*, M243-05V*, M244-05V*, M246-05V*, M242-01W*, M243-01W*, M244-01W*, M246-01W*, M242-05W*, M243-05W*, M244-05W*, M246-05W* (all inputs other than 300-600V)</p> <p>M242-01N*, M243-01N*, M244-01N*, M246-01N*, M242-05N*, M243-05N*, M244-05N*, M246-05N*, (all inputs other than 150-300V)</p> <p>M242-01A*, M243-01A*, M244-01A*, M246-01A*, M242-01C*, M243-01C*, M244-01C*, M246-01C*, M242-01R*, M243-01R*, M244-01R*, M246-01R*, M242-01S*, M243-01S*, M244-01S*, M246-01S*,</p> <p>M242-05A*, M243-05A*, M244-05A*, M246-05A*, M242-05C*, M243-05C*, M244-05C*, M246-05C*, M242-05R*, M243-05R*, M244-05R*, M246-05R*, M242-05S*, M243-05S*, M244-05S*, M246-05S*,</p> <p>M244-80E*, M244-21*, M244-31*, M244-42*, M244-136*, M244-HW*, M244-HX*, M244-41*</p>					M242-02*	M244-14*			
Installation category (Vrms)	CAT III 600V					CAT II 600V / CAT III 300V				CAT III 400V
Test voltage (specified for double or reinforced insulation)	5,2 kV					3,7 kV				5,2 kV

Applicable Standards

Type	M242-02* M243-02* M244-02* M246-02*	M242-01* M243-01* M244-01* M246-01* (except moving coil rectified)	M242-05* M243-05* M244-05* M246-05* (except moving coil rectified)	M242-01B*, M243-01B*, M244-01B*, M246-01B*, M242-01W*, M243-01W*, M244-01W*, M242-05B*, M243-05B*, M244-05B*, M246-05B*, M242-05W*, M243-05W*, M244-05W*, M246-05W*, M244- 2E*, M244-12P*	M243-01Q* M244-01Q*	E244-41S* E244-41L* E244-41D*	E244-41R E244-41E
Standards	EN 60051-1 EN 60051-2 EN 60051-9 EN 61326-1 EN 61010-1	EN 60051-1 EN 60051-2 EN 60051-9 EN 61010-1 EN 61326-1	EN 60051-1 EN 60051-2 EN 60051-9 EN 61010-1 EN 61326-1	EN 60051-1 EN 60051-2 EN 60051-9 EN 61010-1 EN 61326-2	EN60051-1 EN60051-9 EN61010-1	EN 60051-1 EN 60051-4 EN 60051-9 EN 61010-1 EN 61326-1	EN 60051-1 EN 60051-4 EN 60051-9 EN 61010-1 EN 61326-1
Type	M244-21* M244-31*	M244-13* M244-42*	M244-HW* M244-HX*	M244-14*	M244-80L*		
Standards	EN 60051-1 EN 60051-5 EN 60051-9 EN 61010-1 EN 61326-1	EN 60051-1 EN 60051-3 EN 60051-9 EN 61010-1 EN 61326-1	EN 60051-1 EN 60051-3 EN 60051-9 EN 61010-1 EN 61326-1	EN 60051-5 EN 61010-1 EN 61326-1	EN 60051-1 EN 60051-4 EN 60051-9 EN 61010-1 EN 61326-1		

* denotes an abbreviation of the catalogue number as shown on previous pages.

BV Approvals

Type	M24*-02**-S, M244-02Q-S, M244-80-L-S, M244-12-P-S	M244-21*-S, M244-31*-S, M244-42*-S, M244-13*-S, M24*-01**-S, M24*-05**-S, M244-H*x-S, M24*-01**-S, M244-02E-S, M24*-05**-S	M244-41R-S, M244-41E-S, M244-41S-S, M244-41L-S, M244-41D-S	M244-14*-S
Certificate number	38933/AO BV	38940/AO BV	38941/AO BV	38942/AO BV

About TE Connectivity

TE Connectivity (NYSE: TEL) is a \$13 billion world leader in connectivity. The company designs and manufactures products at the heart of electronic connections for the world's leading industries including automotive, energy and industrial, broadband communications, consumer devices, healthcare, and aerospace and defense. TE Connectivity's longstanding commitment to innovation and engineering excellence helps its customers solve the need for more energy efficiency, always-on communications and ever-increasing productivity. With nearly 90,000 employees in over 50 countries, TE Connectivity makes connections the world relies on to work flawlessly every day. To connect with the company, visit: www.te.com.

- Mining
- Nuclear power plants
- OEMs
- Overhead distribution
- Petrochemical plants
- Railways
- Street lighting
- Substations
- Transmission lines
- Underground distribution
- Windfarms
- Solar
- Hydro-electric

WHEREVER ELECTRICITY FLOWS, YOU'LL FIND TE ENERGY



crompton-instruments.com

For email, phone or live chat, go to:

crompton-instruments.com

FOR MORE INFORMATION: TE Technical Support Centres

UK +44 1376 509 533
USA: +1-800-327-6996
Australia +61 1300-656-090
Singapore +65 6590 5151
Hong Kong: +852 - 2790 9609

te.com/energy

© 2015 TE Connectivity Ltd. family of companies. All Rights Reserved. EPP-2410-10/15

TE Connectivity and the TE connectivity (logo) are trademarks of the TE Connectivity Ltd. family of companies. Crompton is a trademark of Crompton Parkinson and is used under a licence. Other logos, product and Company names mentioned herein may be trademarks of their respective owners. While TE has made every reasonable effort to ensure the accuracy of the information in this brochure, TE does not guarantee that it is error-free, nor does TE make any other representation, warranty or guarantee that the information is accurate, correct, reliable or current. TE reserves the right to make any adjustments to the information contained herein at any time without notice. TE expressly disclaims all implied warranties regarding the information contained herein, including, but not limited to, any implied warranties of merchantability or fitness for a particular purpose. The dimensions in this brochure are for reference purposes only and are subject to change without notice. Specifications are subject to change without notice. Consult TE for the latest dimensions and design specifications.