



- Precision 2-Step Reactive Power Overload Protection, not affected by heavily distorted waveforms
- Total processing time less than 50mS
- 3 or 4-wire systems. Definite time trip delays
- Triple relay operation gives more flexibility
- Up to two individual very fast analogue output signals (<50mS), (optional)
- Wide range setting of high overload contact hysteresis
- DIN96 Slave Indicator with status LEDs (optional)

Specifications

Monitored Voltage:	100-120V, 200-240V, 380-415V, 440-460V, 480VAC 40-70Hz (Fuse 0,5A)
Optional Separate Auxiliary Voltage AC:	100-120V, 200-240V, 380-415V, 440-460V, 480VAC 40-70Hz (Fuse 0,5A)
Optional Separate Auxiliary Voltage DC:	24-60VDC (Fuse 0,5A) 110-220VDC (Fuse 1A)
Supply tolerance:	+10%, -20%
Power rating:	5VA
Current Input:	1A CT or 5A CT, <0,1VA
Contact rating:	AC: 100VA -250V/2A max. DC: 50W -100V/1A max.
Adjustments:	Depending on the selected model (see page 2)
Output kVA range:	Any % of the scale
Analogue output 1: (see page 3 for available outputs)	mA: Up to 20mA, max 500R V: Up to 10V, min 100kohm (other on request)
Analogue output 2: (see page 3 for available outputs)	mA: Up to 20mA, max 500R V: Up to 10V, min 500ohm (other on request)
Accuracy:	Class 0,5
Temperature:	-20 to +70°C
Humidity, relative:	0-95%
Weight:	0,6kgs
Front protection:	IP21
Flammability:	UL94-V0

The unit meets EN 60255-27 Cat. III, Pollution degree 2 and the relevant environmental and EMC tests specified in EN 60255-26 to comply with the requirements of the major Classification Societies.

Related information:
The KCVA19x series are also available for panel mounting as KPVA19x series.

Description

The digital controlled KCVA19x range provides precision (1.0%) 2-step reactive power overload protection and monitoring of three phase generators or motors.

Available for 3-phase 3-wire (2R3) and 4-wire (3R4) systems.

The unit measures the voltage and current true r.m.s. value, and accuracy is independent of any wave form distortion.

The standard models takes the auxiliary supply voltage from the monitored voltage (terminal 1 & 2).

It can also be delivered with optional separate AC or DC auxiliary voltage (terminal 26 & 27), but that must be specified when ordering (see page 3 for ordering code for separate Aux. Supply).

User settable trip levels and delays. Colour of LEDs indicate alarm status. Alarm LEDs flash during count-down.

LED status		
Power	Level 1	Level 2
Normal	Alarm	Alarm

Start of monitoring function is delayed when power is switched on (default 2 secs delay). In this way false tripping during power up is avoided.

The DIN-rail mounted instrument reads the power level directly in kVA. The optional slave watt-meter and the triple-zone status LEDs at a glance gives the clear safety message:

- LEVEL 2
- LEVEL 1
- NORMAL

OUTPUTS

Up to two individual very fast analogue output signals (optional) proportional to kW range (see page 2 for models with outputs). If output is used for remote meter reading, we recommend 0-1mA for the slave indicator.

RELAY OUTPUTS

Relay operation depends on the selected model (see page 2). Other combinations are available on request.

Description

KCVA191x

Both overload relays can be used for non-essential load release or as an alarm indication.

A wide range overload contact hysteresis can be set to enable R2 to be used for a non-essential load to be reconnected or as a standby generator stop signal. Relay R3 is an additional relay that can be used for local indication, as an input to an alarm system etc.

A trip LED flashes when the trip level is passed, the relay trips when the delay has elapsed. The timer resets if the fault is removed during countdown.

Relay Operation

The relay operation is delayed in the arrow direction, the reset is instantaneous. Both trip levels can, independently, individually set over the scale range (0-100% FSD).

Configuration: 3-Phase, 3-Wire (2R3)

Relay	O/L Level 1	O/L Level 2	N/A	Fail Safe	Latch	Fixed Hysteresis	Adjustable Hysteresis	N/A	N/A
R1	X				X		X		
R2		X		X	X		X		
R3	X	X			X				

Models	Latch	Output 1	Output 2
KCVA191E	-	-	-
KCVA191G	X	-	-
KCVA191FA	-	X	-
KCVA191GFA	X	X	-
KCVA191FB	-	X	X
KCVA191GFB	X	X	X

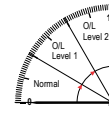

Adjustments	Trip level	Delay
Overload level 1:	0-100% of FSD	0-30secs
Overload Level 2:	0-100% of FSD	0-30secs
Hysteresis L.1:	2-50% of FSD	
Hysteresis L.2:	2-50% of FSD	

Relays shown de-energised. R2 is fail-safe and energises when unit is powered.

KCVA194x

Both overload relays can be used for non-essential load release or as an alarm indication.

A wide range overload contact hysteresis can be set to enable R2 to be used for a non-essential load to be reconnected or as a standby generator stop signal. Relay R3 is an additional relay that can be used for local indication, as an input to an alarm system etc.

A trip LED flashes when the trip level is passed, the relay trips when the delay has elapsed. The timer resets if the fault is removed during countdown.

Configuration: 3-Phase, 4-Wire (3R4)

Relay	O/L Level 1	O/L Level 2	N/A	Fail Safe	Latch	Fixed Hysteresis	Adjustable Hysteresis	N/A	N/A
R1	X				X		X		
R2		X		X	X		X		
R3	X	X			X				

Models	Latch	Output 1	Output 2
KCVA194E	-	-	-
KCVA194G	X	-	-
KCVA194FA	-	X	-
KCVA194GFA	X	X	-
KCVA194FB	-	X	X
KCVA194GFB	X	X	X

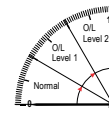

Adjustments	Trip level	Delay
Overload level 1:	0-100% of FSD	0-30secs
Overload Level 2:	0-100% of FSD	0-30secs
Hysteresis L.1:	2-50% of FSD	
Hysteresis L.2:	2-50% of FSD	

Relays shown de-energised. R2 is fail-safe and energises when unit is powered.

KCVA191x2

Both overload relays can be used for non-essential load release or as an alarm indication.

A wide range overload contact hysteresis can be set to enable R2 to be used for a non-essential load to be reconnected or as a standby generator stop signal. Relay R3 is an additional relay that can be used for local indication, as an input to an alarm system etc.

A trip LED flashes when the trip level is passed, the relay trips when the delay has elapsed. The timer resets if the fault is removed during countdown.

Configuration: 3-Phase, 3-Wire (2R3)

Relay	O/L Level 1	O/L Level 2	N/A	Fail Safe	Latch	Fixed Hysteresis	Adjustable Hysteresis	N/A	N/A
R1	X				X				
R2		X					X		
R3	X	X							

Models	Latch	Output 1	Output 2
KCVA191E2	-	-	-
KCVA191G2	X	-	-
KCVA191FA2	-	X	-
KCVA191GFA2	X	X	-
KCVA191FB2	-	X	X
KCVA191GFB2	X	X	X

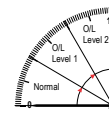

Adjustments	Trip level	Delay
Overload level 1:	0-100% of FSD	0-3secs
Overload Level 2:	0-100% of FSD	0-3secs
Hysteresis L.1:	N/A	
Hysteresis L.2:	2-50% of FSD	

Relays shown de-energised.

KCVA194x2

Both overload relays can be used for non-essential load release or as an alarm indication.

A wide range overload contact hysteresis can be set to enable R2 to be used for a non-essential load to be reconnected or as a standby generator stop signal. Relay R3 is an additional relay that can be used for local indication, as an input to an alarm system etc.

A trip LED flashes when the trip level is passed, the relay trips when the delay has elapsed. The timer resets if the fault is removed during countdown.

Configuration: 3-Phase, 4-Wire (3R4)

Relay	O/L Level 1	O/L Level 2	N/A	Fail Safe	Latch	Fixed Hysteresis	Adjustable Hysteresis	N/A	N/A
R1	X				X				
R2		X					X		
R3	X	X							

Models	Latch	Output 1	Output 2
KCVA194E2	-	-	-
KCVA194G2	X	-	-
KCVA194FA2	-	X	-
KCVA194GFA2	X	X	-
KCVA194FB2	-	X	X
KCVA194GFB2	X	X	X

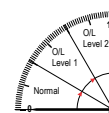

Adjustments	Trip level	Delay
Overload level 1:	0-100% of FSD	0-3secs
Overload Level 2:	0-100% of FSD	0-3secs
Hysteresis L.1:	N/A	
Hysteresis L.2:	2-50% of FSD	

Relays shown de-energised.

The MEGAICON policy is one of continuous improvement, consequently equipment supplied may vary in detail from this publication.

Depending on application, select the model that matches the electrical installation. If none of the listed models fit your purpose please contact Megacon for customer adaptation.



Connection Diagram

Connection Diagram without optional slave instrument

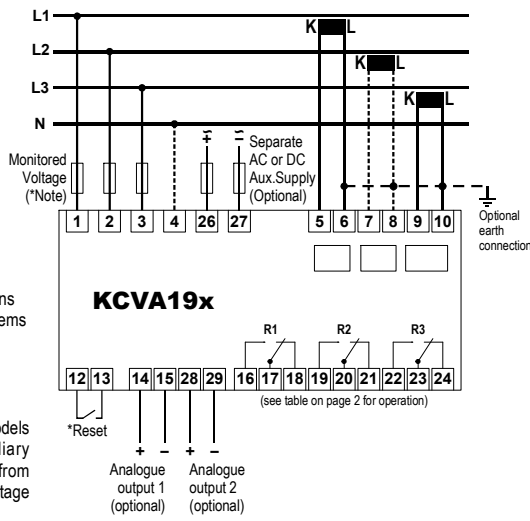

NB!
Dotted connections are for 4-wire systems

***Note:**
The standard models takes the auxiliary supply voltage from the monitored voltage (terminal 1 & 2).

Connection Diagram with optional slave instrument

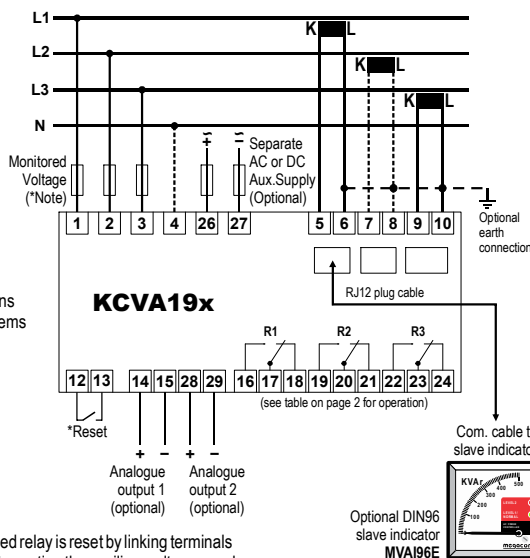

NB!
Dotted connections are for 4-wire systems

***Reset:** Any latched relay is reset by linking terminals 12 and 13 or by interrupting the auxiliary voltage supply.

NB! To ensure correct kVAr measurement, the voltage phase sequence and CT connections must be as shown on connection diagrams.

Analogue Output

The output signals are proportional to the meter reading (see page 2 for an overview of models and functions).

The signal is specifically intended as an input to a control system for monitoring or control.

Add suffix from table below to type designation to specify output required:

Outputs 1

O/P1	0 - 10mA
O/P2	0 - 20mA
O/P3	4 - 20mA
O/P4	N/A
O/P5	N/A
O/P6	N/A
O/P7	N/A
O/P8	0 - 10V
O/P9	0,2 - 10V
O/P10	4,3 - 20mA

Outputs 2

O/P11	0 - 10mA
O/P12	0 - 20mA
O/P13	4 - 20mA
O/P14	N/A
O/P15	N/A
O/P16	N/A
O/P17	N/A
O/P18	0 - 10V
O/P19	0,2 - 10V
O/P20	4,3 - 20mA

Relay Contacts

Burden on supply	: 170mW per relay
Switching voltage (Max)	: 400V AC, 300V DC
Switching voltage (Rated)	: 250V AC, 30V DC
Max I continuous	: 6A RMS, 6A DC
Max breaking capacity	: 1500VA AC, 18-120W DC
Dielectric strength across Open contacts	: 1000V RMS

Connection

Terminal type	: Terminal Clamp and Screw
Wire max.	: T1-T4, T5-T10: AWG 24-14, other terminals: AWG 24-12
Screw Torque	: 0.5Nm

Overload

Voltage	: 1.2 x Un continuous 2 x Un for 10secs
Current	: 2.5 x In continuous 5 x In for 1secs (max 25A)

Dimensions

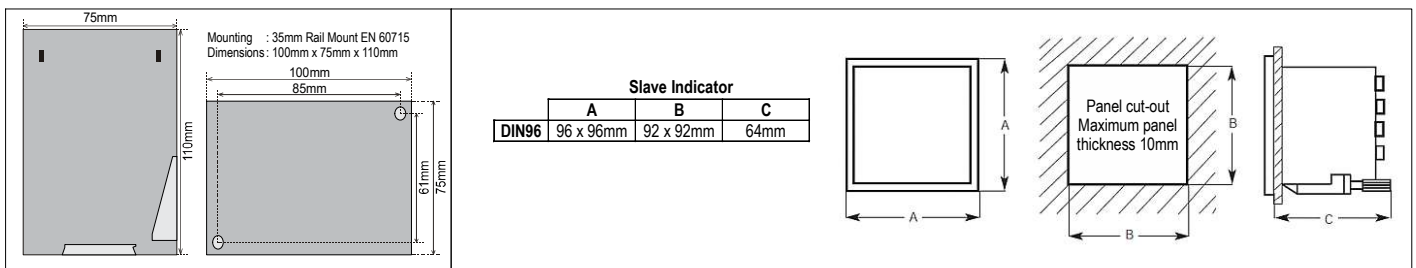

The MEGAcon policy is one of continuous improvement, consequently equipment supplied may vary in detail from this publication.

ORDERING INFORMATION (Example)

Type	: KCVA191FB
Aux. Supply	: 200-240VAC
Input Voltage	: 230V
Input Current C.T.	: 1500/5A
Range	: 0-600kVAr
Analogue output 1	: O/P3: 4-20mA
Analogue output 2	: O/P18: 0-10VDC

Optional Separate Aux. Supply:

Add **-SA** for models with Separate AC Aux. Supply. (Example: KCVA191FB-SA)

Add **-SD** for models with Separate DC Aux. Supply. (Example: KCVA191FB-SD)

