



- Precision Generator AVR Reactive Power Guard, not affected by heavily distorted waveforms
- Total processing time less than 50mS
- Available for 3-phase, 3-wire (2R3) or 4-wire (3R4) systems
- 2-level overload protection (F versions)
- Up to two individual very fast analogue output signals (<50mS), (optional)
- Wide range setting of overload contact hysteresis
- DIN96 Slave Indicator with status LEDs (optional)

Specifications

Monitored Voltage:	100-120V, 200-240V, 380-415V, 440-460V, 480VAC 40-70Hz (Fuse 0,5A)
Optional Separate Auxiliary Voltage AC:	100-120V, 200-240V, 380-415V, 440-460V, 480VAC 40-70Hz (Fuse 0,5A)
Optional Separate Auxiliary Voltage DC:	24-60VDC (Fuse 0,5A) 110-220VDC (Fuse 1A)
Supply tolerance:	+10%, -20%
Power rating:	5VA
Current Input:	1A CT or 5A CT, <0,1VA
Contact rating:	AC: 100VA -250V/2A max. DC: 50W -100V/1A max.
Adjustments:	Depending on the selected model (see page 2)
Output kVAr range:	Any % of the scale
Analogue output 1: (see page 3 for available outputs)	mA: Up to 20mA, max 500R V: Up to 10V, min 100kohm (other on request)
Analogue output 2: (see page 3 for available outputs)	mA: Up to 20mA, max 500R V: Up to 10V, min 500ohm (other on request)
Accuracy:	Class 0,5
Temperature:	-20 to +70°C
Humidity, relative:	0-95%
Weight:	0.6kgs
Front protection:	IP21
Flammability:	UL94-V0

The unit meets EN 60255-27 Cat. III, Pollution degree 2 and the relevant environmental and EMC tests specified in EN 60255-26 to comply with the requirements of the major Classification Societies.

Related information:
The KCVA17x series are also available for panel mounting as KPVA17x series.

Description

The digital controlled KCVA17x range provides precision (1.0%) reactive power and overload protection and monitoring of three phase generators. In cases where the AVR is failing - there will be an increase or decrease in the excitation voltage from the AVR.

Increasing voltage give export (overload) kVAr and decreasing voltage will give import (reverse) of kVAr.

The unit measures the voltage and current true r.m.s. value, and accuracy is independent of any wave form distortion.

It can also be delivered with optional separate AC or DC auxiliary voltage (terminal 26 & 27), but that must be specified when ordering. (see page 3 for ordering code for separate Aux. Supply)

User settable trip levels and delays. Colour of LEDs indicate alarm status. Alarm LEDs flash during count-down.

LED status			LED status		
Power	O/L	R/P	Power / O/L1	O/L2	R/P
Normal	Alarm	Alarm	Normal / Alarm	Alarm	Alarm

See page 2 for models with 2 x O/L

Start of monitoring function is delayed when power is switched on (default 2 secs delay). In this way false tripping during power up is avoided.

The DIN-rail mounted instrument reads the power level directly in kVAr. The optional slave watt-meter and the triple-zone status LEDs at a glance gives the clear safety message:

- OVERLOAD
- NORMAL
- REVERSE POWER

OUTPUTS

Up to two individual very fast analogue output signals (optional) proportional to kVAr range (see page 2 for models with outputs). This may be used as an input to a control system, to detect abnormal power conditions (loss of excitation etc). If output is used for remote meter reading, we recommend 0-1mA for the slave indicator.

RELAY OUTPUTS

Relay operation depends on the selected model (see page 2). Other combinations are available on request.

Description

KCVA171C / H - KCVA176AA / AB - KCVA176HA / HB

Both the reverse power (Import) relay (R1) and the overload (export) relay R2 is used to trip the generator breaker.

Relay R3 is intended for notification of a reverse power condition, or can be used for local indication, as input to an alarm system etc. R1 and R3 will latch after trip.

R2 are non-latching and have a adjustable hysteresis.

Relay Operation

The relay operation is delayed in the arrow direction, the reset is instantaneous. Both trip levels can, independently, individually set over the scale range (0-100% FSD).

Configuration: 3-Phase, 3-Wire (2R3)

Meter: Bi-Polar 1

Relay	O/L 1	O/L 2	R/P	Fail Safe	Latch	Fixed Hysteresis	Adjustable Hysteresis	N/A	N/A
R1			X	X	X				
R2	X						X		
R3			X		X				

Models	Latch	Output 1	Output 2
KCVA171C	X	-	-
KCVA171H	-	-	-
KCVA176AA	X	X	-
KCVA176AB	X	X	X
KCVA176HA	-	X	-
KCVA176HB	-	X	X

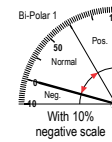

Adjustments	Trip level	Delay
O/L1:	0-100% of FSD	0-30secs
O/L2:	N/A	N/A
R/P:	0-20% of FSD	0-30secs
Hysteresis:	2-50%	

Relays shown de-energised. R1 is fail-safe and energises when unit is powered.

KCVA171F / HF - KCVA176FA / FB - KCVA176HFA / FB

Both the reverse power (Import) relay (R1) and the overload (export) relay R3 is used to trip the generator breaker.

Relay R2 is intended for trip of non-essential load or tripping of bus-tie breaker to split up the system to reduce risk of total black out.

R2 and R3 are non-latching and have a 10% fixed hysteresis.

Configuration: 3-Phase, 3-Wire (2R3)

Meter: Bi-Polar 1

Relay	O/L 1	O/L 2	R/P	Fail Safe	Latch	Fixed Hysteresis	Adjustable Hysteresis	N/A	N/A
R1			X	X	X				
R2	X					X			
R3		X				X			

Models	Latch	Output 1	Output 2
KCVA171F	X	-	-
KCVA171HF	-	-	-
KCVA176FA	X	X	-
KCVA176FB	X	X	X
KCVA176HFA	-	X	-
KCVA176HFB	-	X	X

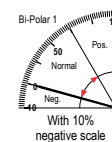

Adjustments	Trip level	Delay
O/L1:	0-100% of FSD	0-30secs
O/L2:	0-100% of FSD	0-30secs
R/P:	0-20% of FSD	0-30secs
Hysteresis:	Fixed 10%	

Relays shown de-energised. R1 is fail-safe and energises when unit is powered.

KCVA174C / H - KCVA177AA / AB - KCVA177HA / HB

Both the reverse power (Import) relay (R1) and the overload (export) relay R2 is used to trip the generator breaker.

Relay R3 is intended for notification of a reverse power condition, or can be used for local indication, as input to an alarm system etc. R1 and R3 will latch after trip.

R2 are non-latching and have a adjustable hysteresis.

Configuration: 3-Phase, 4-Wire (3R4)

Meter: Bi-Polar 1

Relay	O/L 1	O/L 2	R/P	Fail Safe	Latch	Fixed Hysteresis	Adjustable Hysteresis	N/A	N/A
R1			X	X	X				
R2	X						X		
R3			X		X				

Models	Latch	Output 1	Output 2
KCVA174C	X	-	-
KCVA174H	-	-	-
KCVA177AA	X	X	-
KCVA177AB	X	X	X
KCVA177HA	-	X	-
KCVA177HB	-	X	X

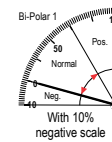

Adjustments	Trip level	Delay
O/L1:	0-100% of FSD	0-30secs
O/L2:	N/A	N/A
R/P:	0-20% of FSD	0-30secs
Hysteresis:	2-50%	

Relays shown de-energised. R1 is fail-safe and energises when unit is powered.

KCVA174F / HF - KCVA177FA / FB - KCVA177HFA / FB

Both the reverse power (Import) relay (R1) and the overload (export) relay R3 is used to trip the generator breaker.

Relay R2 is intended for trip of non-essential load or tripping of bus-tie breaker to split up the system to reduce risk of total black out.

R2 and R3 are non-latching and have a 10% fixed hysteresis.

Configuration: 3-Phase, 4-Wire (3R4)

Meter: Bi-Polar 1

Relay	O/L 1	O/L 2	R/P	Fail Safe	Latch	Fixed Hysteresis	Adjustable Hysteresis	N/A	N/A
R1			X	X	X				
R2	X					X			
R3		X				X			

Models	Latch	Output 1	Output 2
KCVA174F	X	-	-
KCVA174HF	-	-	-
KCVA177FA	X	X	-
KCVA177FB	X	X	X
KCVA177HFA	-	X	-
KCVA177HFB	-	X	X

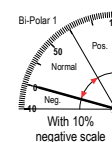

Adjustments	Trip level	Delay
O/L1:	0-100% of FSD	0-30secs
O/L2:	0-100% of FSD	0-30secs
R/P:	0-20% of FSD	0-30secs
Hysteresis:	Fixed 10%	

Relays shown de-energised. R1 is fail-safe and energises when unit is powered.

The MEGAICON policy is one of continuous improvement, consequently equipment supplied may vary in detail from this publication.

Depending on application, select the model that matches the electrical installation. If none of the listed models fit your purpose please contact Megacon for customer adaptation.



Connection Diagram

Connection Diagram without optional slave instrument

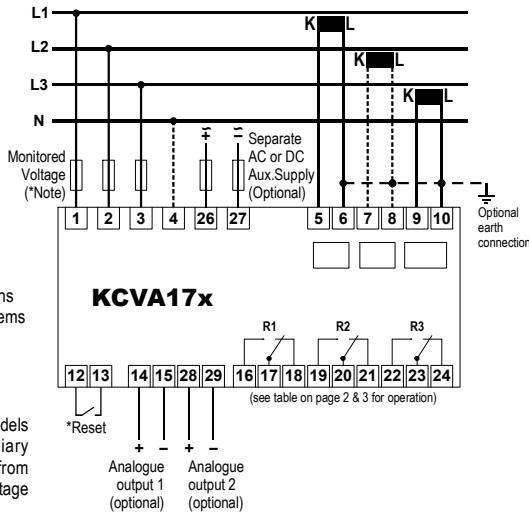

NB!
Dotted connections are for 4-wire systems

***Note:**
The standard models takes the auxiliary supply voltage from the monitored voltage (terminal 1 & 2).

Connection Diagram with optional slave instrument

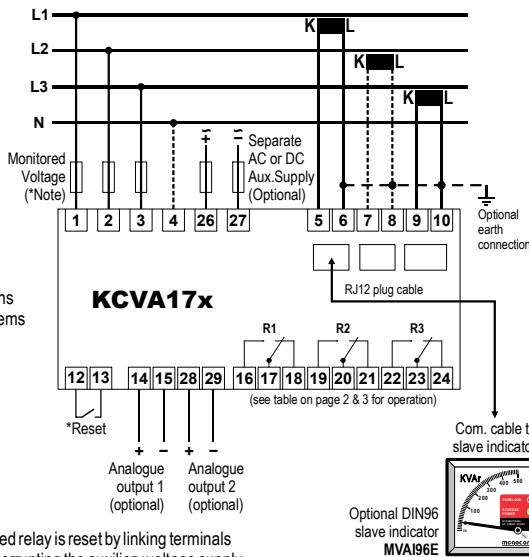

NB!
Dotted connections are for 4-wire systems

***Reset:** Any latched relay is reset by linking terminals 12 and 13 or by interrupting the auxiliary voltage supply.

NB! To ensure correct kVAr measurement, the voltage phase sequence and CT connections must be as shown on connection diagrams.

Analogue Output

The output signals are proportional to the meter reading (see page 2 & 3 for an overview of models and functions).

The signal is specifically intended as an input to a control system for monitoring or control.

Add suffix from table below to type designation to specify output required:

Outputs 1

O/P1	0 - 10mA
O/P2	0 - 20mA
O/P3	4 - 20mA
O/P4	N/A
O/P5	4 - 5,45 - 20mA
O/P6	-10 - 0 - +10mA
O/P7	-20 - 0 - +20mA
O/P8	0 - 10V
O/P9	0,2 - 10V
O/P10	4,3 - 20mA

Outputs 2

O/P11	0 - 10mA
O/P12	0 - 20mA
O/P13	4 - 20mA
O/P14	N/A
O/P15	4 - 5,45 - 20mA
O/P16	-10 - 0 - +10mA
O/P17	-20 - 0 - +20mA
O/P18	0 - 10V
O/P19	0,2 - 10V
O/P20	4,3 - 20mA

Relay Contacts

Burden on supply	: 170mW per relay
Switching voltage (Max)	: 400V AC, 300V DC
Switching voltage (Rated)	: 250V AC, 30V DC
Max I continuous	: 6A RMS, 6A DC
Max breaking capacity	: 1500VA AC, 18-120W DC
Dielectric strength across Open contacts	: 1000V RMS

Connection

Terminal type	: Terminal Clamp and Screw
Wire max.	: T1-T4, T26-T27: AWG 24-14, T5-T10: AWG 12, other terminals: AWG 24-12
Screw Torque	: 0.5Nm

Overload

Voltage	: 1.2 x Un continuous 2 x Un for 10secs
Current	: 2.5 x In continuous 5 x In for 1secs (max 25A)

Dimensions

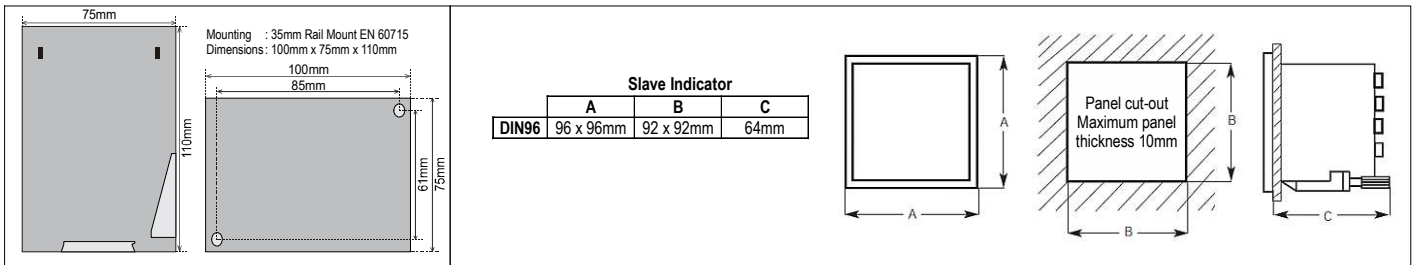

The MEGAcon policy is one of continuous improvement, consequently equipment supplied may vary in detail from this publication.

ORDERING INFORMATION (Example)

Type	: KCVA176AB
Aux. Supply	: 200-240VAC
Input Voltage	: 230V
Input Current C.T.	: 1500/5A
Range	: -60/0/+600kVAr
Analogue output 1	: O/P3: 4-20mA
Analogue output 2	: O/P18: 0-10VDC

Optional Separate Aux. Supply:

Add **-SA** for models with Separate AC Aux. Supply. (Example: KCVA176AA-SA)

Add **-SD** for models with Separate DC Aux. Supply. (Example: KCVA176AB-SD)

